



heikenei.com

HEIKENEI[®]

wir produzieren industrielle lösungen



We Produce Indexable Tool Holders,
Holding Systems & Carbide Inserts.

Your Industrial Solutions Partner.



HOLDING SYSTEMS
BT - BBT - SK - HSK - ISO
2023 V04.23

Since 1983



40
YEARS OF
EXPERIENCE
SINCE 1983

Made in
TÜRKIYE



40
YEARS OF
EXPERIENCE
SINCE 1983

Made in
TÜRKİYE

heikenei.com
info@heikenei.com

HEIKENEI®

wir produzieren industrielle lösungen

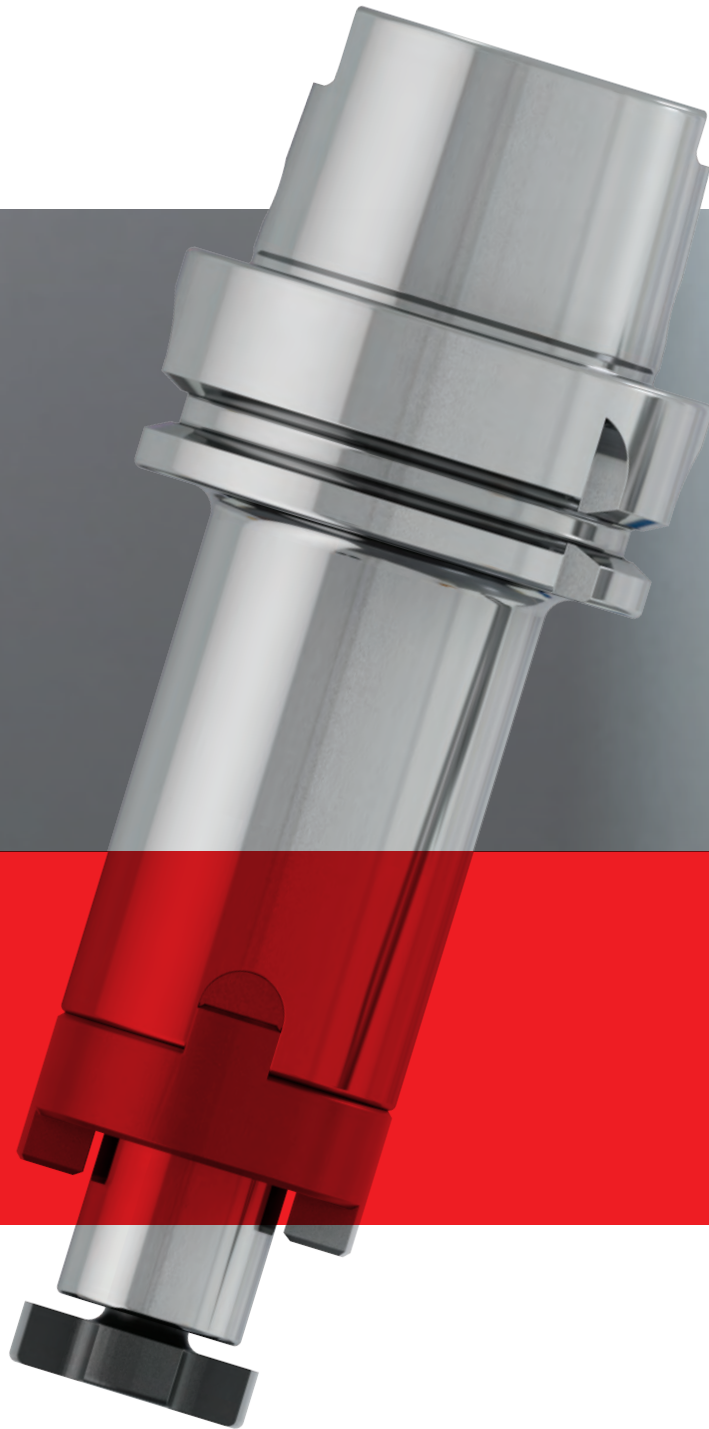

Industrial Machining Tools

2023 SEASON

HEIKENEI TOOLS

HEIKENEI[®]

wir produzieren industrielle lösungen

VISION



Vision

Our vision is to be the world leader in machine tool products, providing our customers with high-quality and creative solutions that will allow their companies' to prosper while contributing to the local economy.

We will work closely with our customers in order to provide optimal products to meet their company goals and needs.

We feel our passion for our products is shared by our customers because of the innovation, quality and design found in each one.

**HEIKENEI TOOLS &
INDUSTRIAL SOLUTIONS**



HEIKENEI®

wir produzieren industrielle lösungen



MISSION



Mission Statement

Heikenei Engineering Solutions Company's mission is to provide first-class quality and innovative machine tools and services in response to our customers' needs. As well to continuously improve in order to meet the ever-changing needs of our customers.

Heikenei also values the commitment, skills, attitude and effort of its employees which is essential for the success of the company.

The organization believes that by maintaining a healthy business relationship with its customers, suppliers, and employees it will result in further growth, success and future prosperity of the organization..

**HEIKENEI TOOLS &
INDUSTRIAL SOLUTIONS**



Istanbul / TURKEY

Augusta, Antonina, Nova Roma, Byzantion, Byzantium, Constantinople and finally Istanbul...

These exciting names remind the mysterious and enchanting past of the city. Istanbul can be considered as the combination of the old and modern city, as well as Islamic and Mediterranean mixture of cultures in a captivating atmosphere. There are only few cities in the world that can be so delightful to experience and enjoy as Istanbul.

A quick look at Istanbul's features more than 8,500 years of history, capital of 3 glorious empires, the Roman, Byzantine and Ottoman Empires, a magical composition of two continents, two Worlds, the East and the West, Islamic and Mediterranean mixture of cultures in a captivating atmosphere, population of more than 15 million, one of world's main air traffic hubs with 2 international airports, 5th most visited city in the world, 2010 European Capital of Culture, 2012 European Capital of Sport, one of world's leading congress destination, connecting 2 continents; Europe and Asia, more than 75 museums, more than 100 lively shopping malls, and 4 historic bazaars, 5 imperial palaces, and many summer palaces, pavilions and mansions, huge transportation network of metro, subway, tram, buses, ferries, sea-buses, etc, 4 seasons throughout the year.

Istanbul is a magical composition of two continents. And especially the Bosphorus, Istanbul Strait will cheer up your hearts. Aside from being the largest and most popular city of Turkey, Istanbul is also the biggest cultural and financial center of Turkey.

Istanbul is considered to be the bridge that links Asia with Europe from a cultural and geographical standpoint.



Istanbul is located partly in Asia and the other part in Europe. Its geographical position as well as its rich history are responsible for a fascinating melting pot of cultures. Tourists are flocking to experience this magical city full of contrasts for themselves, making it the 5th most popular tourist destination in the world.

Istanbul offers an unforgettable experience for its travelers, with its colorful daily city life and dynamic nightlife. The beautiful silhouette of the city combines historical sites and monuments such as Roman aqueducts, Byzantine churches, Venetian towers, Ottoman palaces from the Byzantine, Ottoman and Turkish periods.

And the skyline covers monumental minarets with skyscrapers and plazas. And especially the Historical Peninsula and the Bosphorus will make you deeply fall in love with the city.

Istanbul is also one of the most lively metropolises in the world (having more than 15 million residents) that offers variety of intercontinental events, international film, music and theater festivals, international biennials, and more than 80 museums and many art galleries showcase all the culture, arts and history; including painting, sculpture, photography and more.

As for eating out and gastronomy, it means that you are one step away from tasting the delicious meals of the Turkish cuisine, from spicy and hot Anatolian and Aegean dishes freshly cooked with olive oil. Istanbul offers wide range of Turkish cuisine at the variety of well established, good and luxury Istanbul restaurants.

**HEIKENEI TOOLS &
INDUSTRIAL SOLUTIONS**

BT HOLDING SYSTEMS

heikenei.com



BT COLLET
CHUCKS FOR
COLLETS DIN
6499 ER

5



BT COLLET
CHUCKS FOR
COLLETS DIN
6499 ER MINI

7



BT COLLET
CHUCKS DIN
6391 FOR
COLLETS DIN
6388-OZ

8



BT END MILL
HOLDER DIN
6359 FOR
WELDON DIN
1835-B

9



BT END MILL
HOLDER DIN
6359 FOR
WELDON DIN
1835-B WITH
COOLANT

13



BT END MILL
HOLDER DIN
6359 FOR
WELDON DIN
1835-B WITH
COOLANT
KKB

15



BT SHELL MILL
HOLDER WITH
DRIVING SLOT
& COOLANT

17



BT SHELL
MILL HOLDER
DIN 6357
FOR FACE
MILLS WITH
DRIVING SLOT
& COOLANT

18



BT COMBI
SHELL MILL
HOLDER

19



BT MORSE
TAPER
ADAPTOR

21



BT MORSE
TAPER
ADAPTOR -
WITH THREAD

22



BT
REDUCTION
SLEEVES

23



BT ARBORS
FOR
MODULAR
(SCREW TYPE)
INDEXABLE
END MILLS

24



BT INDEXABLE
DRILLS
HOLDER ET

26



BT BLANK BAR

27

SK HOLDING SYSTEMS



SK COLLET
CHUCKS FOR
COLLETS DIN
6499 ER

31



SK COLLET
CHUCKS DIN
6391 FOR
COLLETS DIN
6388-OZ

33



SK COLLET
CHUCKS FOR
COLLETS DIN
6499 ER MINI

34



SK END MILL
HOLDER DIN
6359 FOR
WELDON DIN
1835-B

35



SK END MILL
HOLDER DIN
6359 FOR
WELDON DIN
1835-B WITH
COOLANT KKB

39



SK END MILL
HOLDER DIN
6359 FOR
WELDON DIN
1835-B WITH
COOLANT K

43



SK SHELL MILL
HOLDER DIN
6357 FOR
CUTTERS WITH
DRIVING SLOT
& COOLANT

45



SK COMBI
SHELL MILL
HOLDER DIN
6358

47



SK MORSE
TAPER
ADAPTOR DIN
6383

49



SK MORSE
TAPER
ADAPTOR
WITH THREAD
DIN 6364

50



SK
REDUCTION
SLEEVES

51



SK INDEXABLE
MILLING
ARBORS FOR
SCREW TYPE

52



SK HOLDER
FOR
INDEXABLE
DRILLS E1

54



SK BLANK
BAR

55

HSK HOLDING SYSTEMS

heikenei.com



HSK-A COLLET
CHUCKS FOR
COLLETS DIN
6499 ER

59



HSK-A COLLET
CHUCKS FOR
COLLETS DIN
6499 ER MINI

60



HSK-A COLLET
CHUCKS DIN
6391 FOR
COLLETS DIN
6388-OZ

61



HSK-A END
MILL HOLDER
DIN 6359 FOR
WELDON DIN
1835-B

62



HSK-A END
MILL HOLDER
DIN 6359 FOR
WELDON DIN
1835-B WITH
COOLANT

65



HSK-A SHELL
MILL HOLDER
DIN 6357 FOR
MILLING WITH
DRIVING SLOT
& COOLANT

70



HSK-A COMBI
SHELL MILL
HOLDER DIN
6358 WITH
COOLANT

72



HSK-A
MORSE TAPER
ADAPTOR DIN
5383

74



HSK-A
MORSE TAPER
ADAPTOR
WITH THREAD
DIN 6364

75



HSK-A FOR
MODULAR
(SCREW TYPE)
INDEXABLE
END MILLS

76



HSK-A
HOLDER FOR
INDEXABLE
DRILLS E1

77



HSK-A BLANK
BAR

78

DIN 2080 SK SYSTEMS



COLLET
CHUCKS FOR
COLLETS DIN
6499 ER

83



COLLET
CHUCKS DIN
6391 FOR
COLLETS DIN
6388-OZ

84



END MILL
HOLDER DIN
6359 FOR
WELDON DIN
1835-B

85



SHELL MILL
HOLDER DIN
6357 FOR
CUTTERS WITH
DRIVING SLOT

86



COMBI SHELL
MILL HOLDER
DIN 6358

87



MORSE TAPER
ADAPTOR DIN
6383

88



MORSE TAPER
ADAPTOR
WITH THREAD
DIN 6364

89



REDUCTION
SLEEVES

90



DRILL CHUCK
ADAPTOR DIN
238

91



BLANK BAR

92

ACCESSORIES

heikenei.com



DRIVING
BLOCKS

93



MINI ER
COLLET

93



ER COLLET

93



OZ COLLET

93



CLUTCH DRIVE
RINGS TO DIN
6366

94



DRAWN IN
BOLT DIN
6367

94



DRIVE KEY

94



CLAMPING
SCREW FOR
WELDON AND
WHISTLE NOTCH

95



SCREW FOR
WELDON DIN
1835 B

95



CLAMPING
SCREW DIN
913 - DIN 914

95

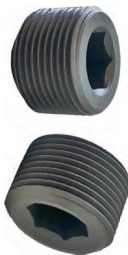

CLAMPING
SCREW DIN
1835 B

95

BT

heikenei.com

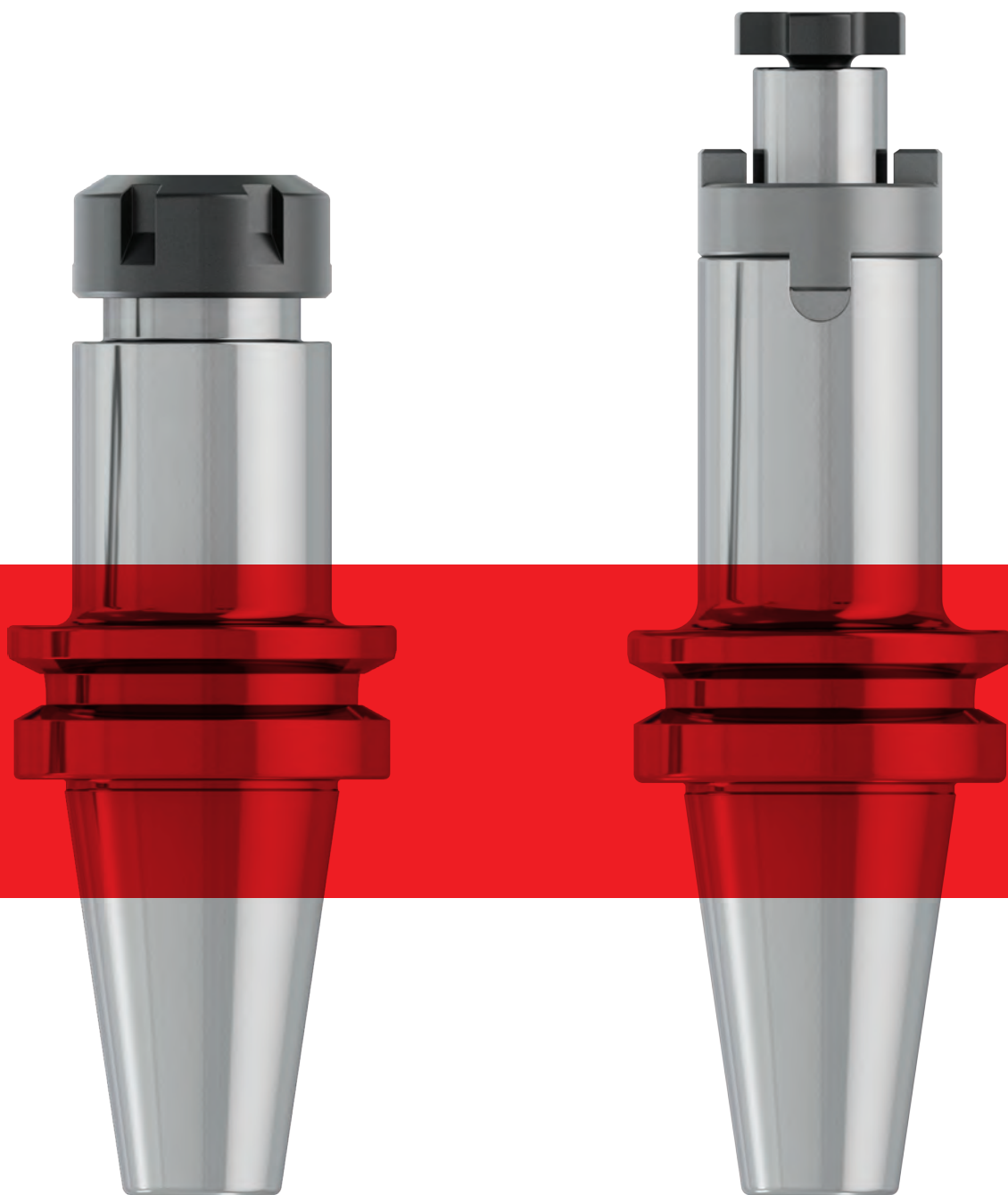

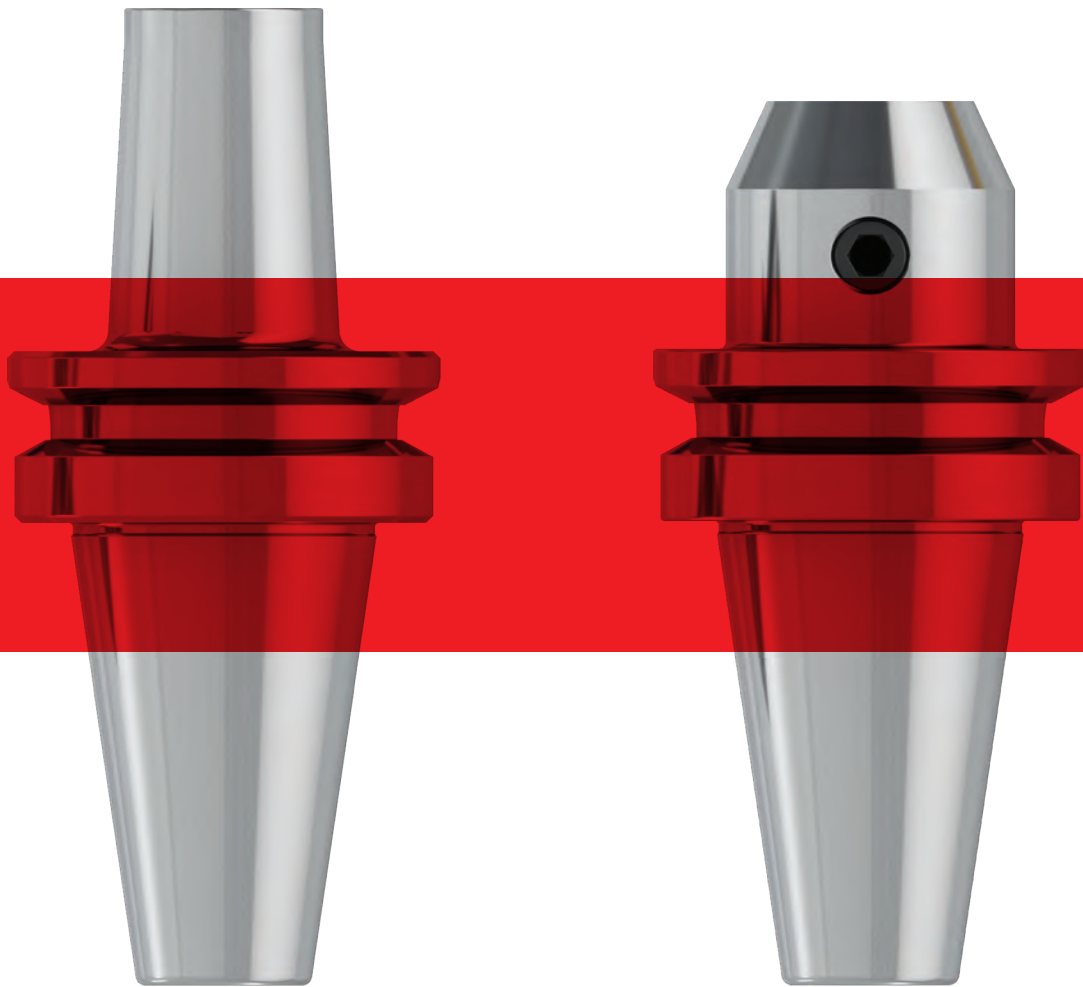

PG. 4 - 27

BT HOLDING SYSTEM DIMENSIONS

heikenei.com

DIN ISO 7388-2 (JIS B 6339 MAS 403 BT)

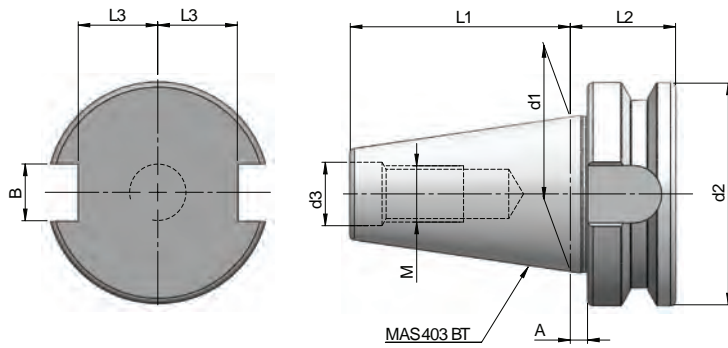

Dimensions	Ø d1	Ø d2	Ø d3	M	A	L1	L2	L3	B
BT 30	31,75	46	12,5	M12	2	48,4	22	16,3	16,1
BT 40	44,45	63	17	M16	2	65,4	27	22,6	16,1
BT 50	69,85	100	25	M24	3	101,8	38	35,4	25,7

BT COLLET CHUCKS FOR COLLETS DIN 6499 ER

DIN ISO 7388-2 AD (JIS B 6339 MAS 403 BT)
SPANNZANGENFUTTER DIN 6499 ER

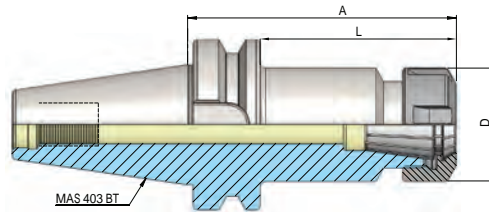
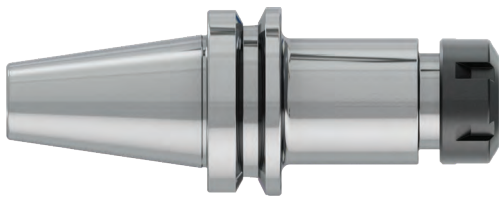

Artikelbezeichnung Item Code	Produktname Product name	Spannbereich Capacity	D	L	A
HEI.B30.0116.70	BT 30 ER 16 - 70	1 - 10	28	48	70
HEI.B30.0116.100	BT 30 ER 16 - 100	1 - 10	28	78	100
HEI.B30.0125.70	BT 30 ER 25 - 70	2 - 16	42	48	70
HEI.B30.0125.100	BT 30 ER 25 - 100	2 - 16	42	78	100
HEI.B30.0132.70	BT 30 ER 32 - 70	2 - 20	50	48	70
HEI.B30.0132.100	BT 30 ER 32 - 100	2 - 20	50	78	100
HEI.B30.0140.70	BT 30 ER 40 - 70	3 - 26	63	48	70
HEI.B40.0116.63	BT 40 ER 16 - 63	1 - 10	28	36	63
HEI.B40.0116.100	BT 40 ER 16 - 100	1 - 10	28	73	100
HEI.B40.0116.130	BT 40 ER 16 - 130	1 - 10	28	103	130
HEI.B40.0116.160	BT 40 ER 16 - 160	1 - 10	28	133	160
HEI.B40.0125.60	BT 40 ER 25 - 60	2 - 16	42	33	60
HEI.B40.0125.100	BT 40 ER 25 - 100	2 - 16	42	73	100
HEI.B40.0125.130	BT 40 ER 25 - 130	2 - 16	42	103	130
HEI.B40.0125.160	BT 40 ER 25 - 160	2 - 16	42	133	160
HEI.B40.0132.70	BT 40 ER 32 - 70	2 - 20	50	43	70
HEI.B40.0132.100	BT 40 ER 32 - 100	2 - 20	50	73	100
HEI.B40.0132.130	BT 40 ER 32 - 130	2 - 20	50	103	130
HEI.B40.0132.160	BT 40 ER 32 - 160	2 - 20	50	133	160
HEI.B40.0140.80	BT 40 ER 40 - 80	3 - 26	63	53	80
HEI.B40.0140.100	BT 40 ER 40 - 100	3 - 26	63	73	100
HEI.B40.0140.130	BT 40 ER 40 - 130	3 - 26	63	103	130
HEI.B40.0140.160	BT 40 ER 40 - 160	3 - 26	63	133	160

BT COLLET CHUCKS FOR COLLETS DIN 6499 ER

DIN ISO 7388-2 AD (JIS B 6339 MAS 403 BT)
SPANNZANGENFUTTER DIN 6499 ER

heikenei.com

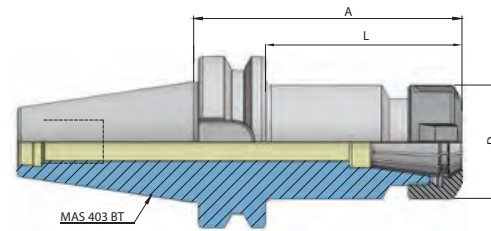

DIN
6339

G 2.5
25.000
MIN

FORM
AD

ISO
7388-2



Artikelbezeichnung Item Code	Produktname Product name	Spannbereich Capacity	D	L	A
HEI.B50.0116.70	BT 50 ER 16 - 70	1 - 10	28	32	70
HEI.B50.0116.100	BT 50 ER 16 - 100	1 - 10	28	62	100
HEI.B50.0116.130	BT 50 ER 16 - 130	1 - 10	28	92	130
HEI.B50.0116.160	BT 50 ER 16 - 160	1 - 10	28	122	160
HEI.B50.0125.70	BT50 ER 25 - 70	2 - 16	42	32	70
HEI.B50.0125.100	BT50 ER 25 - 100	2 - 16	42	62	100
HEI.B50.0125.130	BT50 ER 25 - 130	2 - 16	42	92	130
HEI.B50.0125.160	BT50 ER 25 - 160	2 - 16	42	122	160
HEI.B50.0132.70	BT50 ER 32 - 70	2 - 20	50	32	70
HEI.B50.0132.100	BT50 ER 32 - 100	2 - 20	50	62	100
HEI.B50.0132.130	BT50 ER 32 - 130	2 - 20	50	92	130
HEI.B50.0132.160	BT50 ER 32 - 160	2 - 20	50	122	160
HEI.B50.0140.80	BT50 ER40 - 80	3 - 26	63	42	80
HEI.B50.0140.100	BT50 ER40 - 100	3 - 26	63	62	100
HEI.B50.0140.130	BT50 ER40 - 130	3 - 26	63	92	130
HEI.B50.0140.160	BT50 ER40 - 160	3 - 26	63	122	160

BT COLLET CHUCKS FOR COLLETS DIN 6499 ER MINI

DIN ISO 7388-2 AD (JIS B 6339 MAS 403 BT)

SPANNZANGENFUTTER DIN 6499 ER MINI

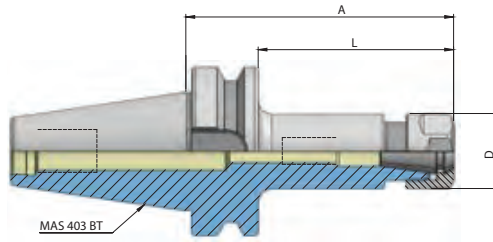
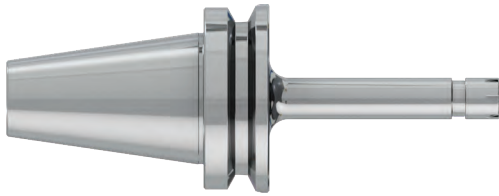

Artikelbezeichnung Item Code	Produktname Product name	Spannbereich Capacity	D	L	A
HEI.B40.0111.100M	BT 40 ER 11 100 - M	1 - 7	16	73	100
HEI.B40.0111.130M	BT 40 ER 11 130 - M	1 - 7	16	103	130
HEI.B40.0111.160M	BT 40 ER 11 160 - M	1 - 7	16	133	160
HEI.B40.0116.100M	BT 40 ER 16 100 - M	1 - 10	22	73	100
HEI.B40.0116.130M	BT 40 ER 16 130 - M	1 - 10	22	103	130
HEI.B40.0116.160M	BT 40 ER 16 160 - M	1 - 10	22	133	160
HEI.B50.0116.100M	BT 50 ER 16 100 - M	1 - 10	22	62	100
HEI.B50.0116.130M	BT 50 ER 16 130 - M	1 - 10	22	92	130
HEI.B50.0116.160M	BT 50 ER 16 160 - M	1 - 10	22	122	160

BT COLLET CHUCKS DIN 6391 FOR COLLETS DIN 6388-OZ

heikenei.com

BT DIN ISO 7388-2 AD (JIS B 6339 MAS 403 BT)

SPANNFUTTER DIN 6391 FÜR SPANNZANGEN DIN 6388-OZ

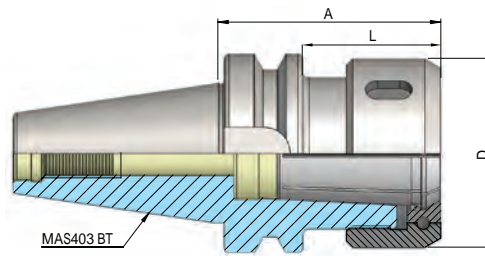

DIN
69893

G 2.5
25.000
MIN

FORM
AD

ISO
7388-2



Artikelbezeichnung Item Code	Produktname Product name	MK	D	L	A
HEI.B30.0116.60.OZ	BT 30 E 416 - 60	2-16	43	38	60
HEI.B30.0125.80.OZ	BT 30 E 462 - 80	2-25	60	58	80
HEI.B40.0116.70.OZ	BT 40 E 416 - 70	2 - 16	43	43	70
HEI.B40.0116.100.OZ	BT 40 E 416 - 100	2 - 16	43	73	100
HEI.B40.0125.70.OZ	BT 40 E 462 - 70	2 - 25	60	43	70
HEI.B40.0125.100.OZ	BT 40 E 462 - 100	2 - 25	60	73	100
HEI.B40.0132.90.OZ	BT 40 E 467 - 90	3 - 32	72	63	90
HEI.B50.0116.70.OZ	BT 50 E 416 - 70	2 - 16	43	32	70
HEI.B50.0125.85.OZ	BT 50 E 462 - 85	2 - 25	60	47	85
HEI.B50.0132.90.OZ	BT 50 E 467 - 90	3 - 32	72	52	90

BT END MILL HOLDER DIN 6359 FOR WELDON DIN 1835-B

DIN ISO 7388-2 AD (JIS B 6339 MAS 403 BT)

FRASERAUFNAHME DIN 6359 ZYLINDERSCHAFTE DIN 1835-B

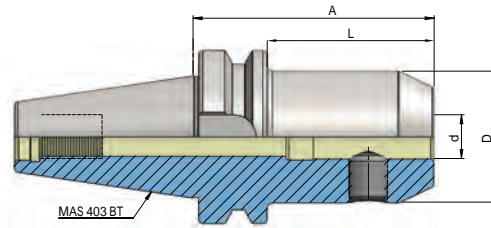
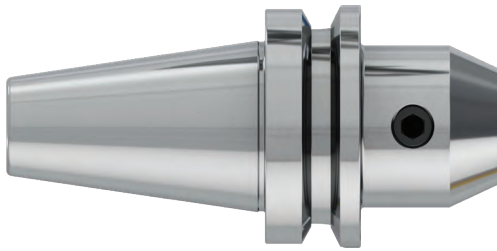

JIS B
6339

G 2.5
**25.000
MIN**

FORM
AD

ISO
7388-2



Artikelbezeichnung Item Code	Produktname Product name	Spannbereich Capacity	D	L	A
HEI.B30.0206.50	BT 30 6 - 50	6	25	28	50
HEI.B30.0208.50	BT 30 8 - 50	8	28	28	50
HEI.B30.0210.50	BT 30 10 - 50	10	35	28	50
HEI.B30.0212.50	BT 30 12 - 50	12	42	28	50
HEI.B30.0214.50	BT 30 14 - 50	14	44	28	50
HEI.B30.0216.63	BT 30 16 - 63	16	48	41	63
HEI.B30.0218.63	BT 30 18 - 63	18	50	41	63
HEI.B30.0220.63	BT 30 20 - 63	20	52	41	63
HEI.B40.0206.50	BT 40 6 - 50	6	25	23	50
HEI.B40.0206.100	BT 40 6 - 100	6	25	73	100
HEI.B40.0206.130	BT 40 6 - 130	6	25	103	130
HEI.B40.0206.160	BT 40 6 - 160	6	25	133	160
HEI.B40.0208.50	BT 40 8 - 50	8	28	23	50
HEI.B40.0208.100	BT 40 8 - 100	8	28	73	100
HEI.B40.0208.130	BT 40 8 - 130	8	28	103	130
HEI.B40.0208.160	BT 40 8 - 160	8	28	133	160
HEI.B40.0210.63	BT 40 10 - 63	10	35	36	63
HEI.B40.0210.100	BT 40 10 - 100	10	35	73	100
HEI.B40.0210.130	BT 40 10 - 130	10	35	103	130
HEI.B40.0210.160	BT 40 10 - 160	10	35	133	160
HEI.B40.0212.63	BT 40 12 - 63	12	42	36	63
HEI.B40.0212.100	BT 40 12 - 100	12	42	73	100
HEI.B40.0212.130	BT 40 12 - 130	12	42	103	130
HEI.B40.0212.160	BT 40 12 - 160	12	42	133	160
HEI.B40.0214.63	BT 40 14 - 63	14	45	36	63
HEI.B40.0214.100	BT 40 14 - 100	14	45	73	100
HEI.B40.0214.160	BT 40 14 - 160	14	45	133	160

BT END MILL HOLDER DIN 6359 FOR WELDON DIN 1835-B

heikenei.com

DIN ISO 7388-2 AD (JIS B 6339 MAS 403 BT)

FRÄSERAUFNAHME DIN 6359 ZYLINDERSCHÄFTE DIN 1835-B

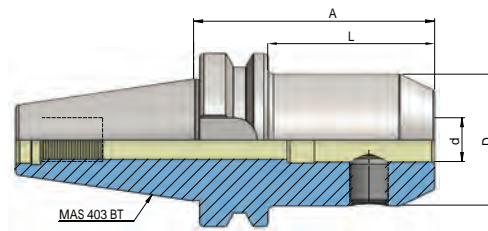
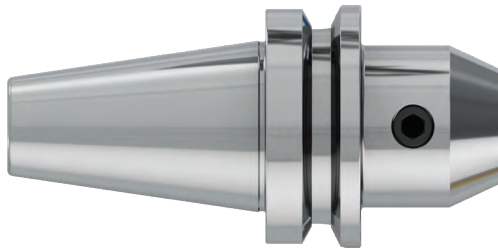

JIS B
6339

G 2.5
25.000
MIN

FORM
AD

ISO
7388-2



Artikelbezeichnung Item Code	Produktname Product name	Spannbereich Capacity	D	L	A
HEI.B40.0216.35	BT 40 16 - 35	16	45	8	35
HEI.B40.0216.63	BT 40 16 - 63	16	48	36	63
HEI.B40.0216.100	BT 40 16 - 100	16	48	73	100
HEI.B40.0216.130	BT 40 16 - 130	16	48	103	130
HEI.B40.0216.160	BT 40 16 - 160	16	48	133	160
HEI.B40.0218.63	BT 40 18 - 63	18	50	36	63
HEI.B40.0218.100	BT 40 18 - 100	18	50	73	100
HEI.B40.0218.160	BT 40 18 - 160	18	50	133	160
HEI.B40.0220.35	BT 40 20 - 35	20	45	8	35
HEI.B40.0220.63	BT 40 20 - 63	20	52	36	63
HEI.B40.0220.100	BT 40 20 - 100	20	52	73	100
HEI.B40.0220.130	BT 40 20 - 130	20	52	103	130
HEI.B40.0220.160	BT 40 20 - 160	20	52	133	160
HEI.B40.0225.35	BT 40 25 - 35	25	45	8	35
HEI.B40.0225.90	BT 40 25 - 90	25	63	63	90
HEI.B40.0225.160	BT 40 25 - 160	25	63	133	160
HEI.B40.0232.65	BT 40 32 - 65	32	63	38	65
HEI.B40.0232.100	BT 40 32 - 100	32	72	73	100
HEI.B40.0232.160	BT 40 32 - 160	32	72	133	160
HEI.B40.0240.120	BT 40 40 - 120	40	80	93	120

BT END MILL HOLDER DIN 6359 FOR WELDON DIN 1835-B

DIN ISO 7388-2 AD (JIS B 6339 MAS 403 BT)

FRÄSERAUFNAHME DIN 6359 ZYLINDERSCHÄFTE DIN 1835-B

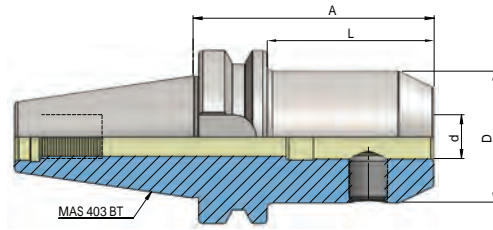
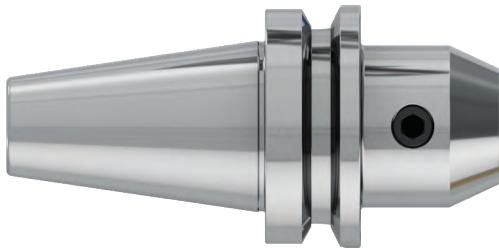

Artikelbezeichnung Item Code	Produktname Product name	Spannbereich Capacity	D	L	A
HEI.B50.0206.63	BT 50 6 - 63	6	25	25	63
HEI.B50.0206.100	BT 50 6 - 100	6	25	62	100
HEI.B50.0206.130	BT 50 6 - 130	6	25	92	130
HEI.B50.0206.160	BT 50 6 - 160	6	25	122	160
HEI.B50.0208.63	BT 50 8 - 63	8	28	25	63
HEI.B50.0208.100	BT 50 8 - 100	8	28	62	100
HEI.B50.0208.130	BT 50 8 - 130	8	28	92	130
HEI.B50.0208.160	BT 50 8 - 160	8	28	122	160
HEI.B50.0210.63	BT 50 10 - 63	10	35	25	63
HEI.B50.0210.100	BT 50 10 - 100	10	35	62	100
HEI.B50.0210.130	BT 50 10 - 130	10	35	92	130
HEI.B50.0210.160	BT 50 10 - 160	10	35	122	160
HEI.B50.0212.80	BT 50 12 - 80	12	42	42	80
HEI.B50.0212.100	BT 50 12 - 100	12	42	62	100
HEI.B50.0212.130	BT 50 12 - 130	12	42	92	130
HEI.B50.0212.160	BT 50 12 - 160	12	42	122	160
HEI.B50.0214.80	BT 50 14 - 80	14	45	42	80
HEI.B50.0214.100	BT 50 14 - 100	14	45	92	100
HEI.B50.0214.160	BT 50 14 - 160	14	45	122	160
HEI.B50.0216.80	BT 50 16 - 80	16	48	42	80
HEI.B50.0216.100	BT 50 16 - 100	16	48	62	100
HEI.B50.0216.130	BT 50 16 - 130	16	48	92	130
HEI.B50.0216.160	BT 50 16 - 160	16	48	122	160

BT END MILL HOLDER DIN 6359 FOR WELDON DIN 1835-B

heikenei.com

DIN ISO 7388-2 AD (JIS B 6339 MAS 403 BT)

FRÄSERAUFNAHME DIN 6359 ZYLINDERSCHÄFTE DIN 1835-B

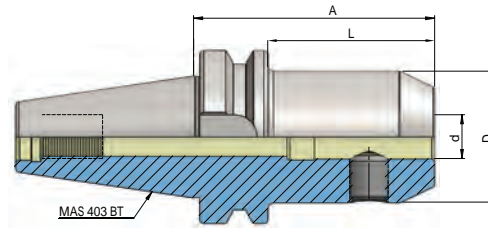
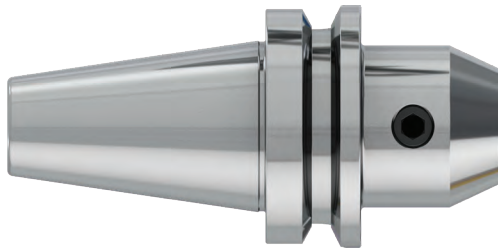

JIS B
6339

G 2.5
25.000
MIN

FORM
AD

ISO
7388-2



Artikelbezeichnung Item Code	Produktname Product name	Spannbereich Capacity	D	L	A
HEI.B50.0218.80	BT 50 18 - 80	18	50	42	80
HEI.B50.0218.100	BT 50 18 - 100	18	50	62	100
HEI.B50.0218.160	BT 50 18 - 160	18	50	122	160
HEI.B50.0220.80	BT 50 20 - 80	20	52	42	80
HEI.B50.0220.100	BT 50 20 - 100	20	52	62	100
HEI.B50.0220.130	BT 50 20 - 130	20	52	92	130
HEI.B50.0220.160	BT 50 20 - 160	20	52	122	160
HEI.B50.0225.100	BT 50 25 - 100	25	65	62	100
HEI.B50.0225.130	BT 50 25 - 130	25	65	92	130
HEI.B50.0225.160	BT 50 25 - 160	25	65	122	160
HEI.B50.0232.105	BT 50 32 - 105	32	72	67	105
HEI.B50.0232.160	BT 50 32 - 160	32	72	122	160
HEI.B50.0240.110	BT 50 40 - 110	40	80	72	110
HEI.B50.0240.160	BT 50 40 - 160	40	80	122	160

BT END MILL HOLDER DIN 6359 FOR WELDON DIN 1835-B WITH COOLANT

DIN ISO 7388-2 AD (JIS B 6339 MAS 403 BT)

FRÄSERAUFNAHME DIN 6359 ZYLINDERSCHÄFTE DIN 1835-B MIT KÜHLMITTEL

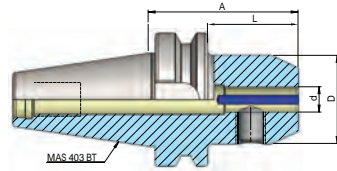
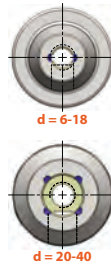
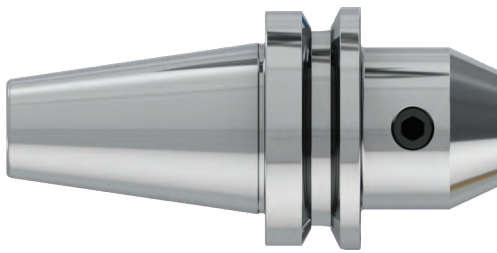

JIS B
6339

G 2.5
25.000
MIN

COOLANT

FORM
AD

ISO
7388-2



Artikelbezeichnung Item Code	Produktname Product name	Spannbereich Capacity	D	L	A
HEI.B40.0206.50K	BT 40 6 - 50 - K	6	25	23	50
HEI.B40.0206.100K	BT 40 6 - 100 - K	6	25	73	100
HEI.B40.0208.50K	BT 40 8 - 50 - K	8	28	23	50
HEI.B40.0208.100K	BT 40 8 - 100 - K	8	28	73	100
HEI.B40.0210.63K	BT 40 10 - 63 - K	10	35	36	63
HEI.B40.0210.100K	BT 40 10 - 100 - K	10	35	73	100
HEI.B40.0212.63K	BT 40 12 - 63 - K	12	42	36	63
HEI.B40.0212.100K	BT 40 12 - 100 - K	12	42	73	100
HEI.B40.0214.63K	BT 40 14 - 63 - K	14	45	36	63
HEI.B40.0214.100K	BK 40 14 - 100 - K	14	45	73	100
HEI.B40.0216.63K	BT 40 16 - 63 - K	16	48	36	63
HEI.B40.0216.100K	BT 40 16 - 100 - K	16	48	73	100
HEI.B40.0218.63K	BT 40 18 - 63 - K	18	50	36	63
HEI.B40.0218.100K	BT 40 18 - 100 - K	18	50	73	100
HEI.B40.0220.63K	BT 40 20 - 63 - K	20	52	36	63
HEI.B40.0220.100K	BT 40 20 - 100 - K	20	52	73	100
HEI.B40.0225.90K	BT 40 25 - 90 - K	25	63	63	90
HEI.B40.0232.100K	BT 40 32 - 100 - K	32	72	73	100
HEI.B40.0240.120K	BT 40 40 - 120 - K	40	80	93	120

BT END MILL HOLDER DIN 6359 FOR WELDON DIN 1835-B WITH COOLANT

heikenei.com

DIN ISO 7388-2 AD (JIS B 6339 MAS 403 BT)

FRÄSERAUFNAHME DIN 6359 ZYLINDERSCHÄFTE DIN 1835-B MIT KÜHLMITTEL

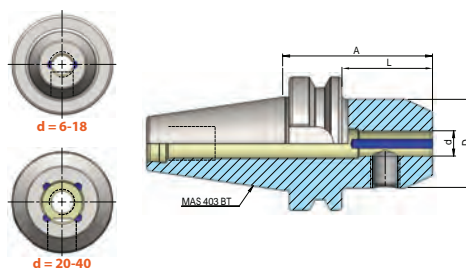

JIS B
6339

G 2.5
25.000
MIN

COOLANT

FORM
AD

ISO
7388-2



Artikelbezeichnung Item Code	Produktname Product name	Spannbereich Capacity	D	L	A
HEI.B50.0206.63K	BT 50 6 - 63 - K	6	25	25	63
HEI.B50.0206.100K	BT 50 6 - 100 - K	6	25	62	100
HEI.B50.0208.63K	BT 50 8 - 63 - K	8	28	25	63
HEI.B50.0208.100K	BT 50 8 - 100 - K	8	28	62	100
HEI.B50.0210.63K	BT 50 10 - 63 - K	10	35	25	63
HEI.B50.0210.100K	BT 50 10 - 100 - K	10	35	62	100
HEI.B50.0212.80K	BT 50 12 - 80 - K	12	42	42	80
HEI.B50.0212.100K	BT 50 12 - 100 - K	12	42	62	100
HEI.B50.0214.80K	BT 50 14 - 80 - K	14	45	42	80
HEI.B50.0214.100K	BT 50 14 - 100 - K	14	45	62	100
HEI.B50.0216.80K	BT 50 16 - 80 - K	16	48	42	80
HEI.B50.0216.100K	BT 50 16 - 100 - K	16	48	62	100
HEI.B50.0218.80K	BT 50 18 - 80 - K	18	50	42	80
HEI.B50.0218.100K	BT 50 18 - 100 - K	18	50	62	100
HEI.B50.0220.80K	BT 50 20 - 80 - K	20	52	42	80
HEI.B50.0220.100K	BT 50 20 - 100 - K	20	52	62	100
HEI.B50.0225.100K	BT 50 25 - 100 - K	25	65	62	100
HEI.B50.0232.105K	BT 50 32 - 105 - K	32	72	67	105
HEI.B50.0240.110K	BT50 40 - 110 - K	40	80	72	110

BT END MILL HOLDER DIN 6359 FOR WELDON DIN 1835-B WITH COOLANT KKB



DIN ISO 7388-2 AD (JIS B 6339 MAS 403 BT)

FRÄSERAUFNAHME DIN 6359 ZYLINDERSCHÄFTE DIN 1835-B MIT KÜHLMITTEL BOHRUNG

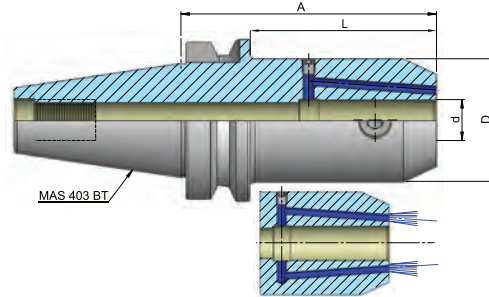
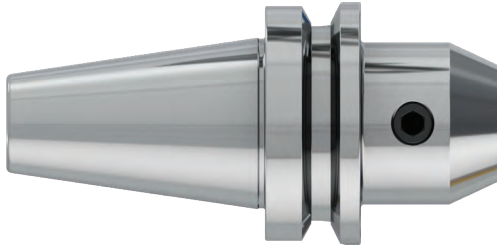

JIS B
6339

G 2.5
25.000
MIN

COOLANT

FORM
AD

ISO
7388-2



Artikelbezeichnung Item Code	Kegel Cone	d	D	L	A
HEI.B40.0206.50-KKB	BT 40	6	25	23	50
HEI.B40.0206.100-KKB	BT 40	6	25	73	100
HEI.B40.0206.130-KKB	BT 40	6	25	103	130
HEI.B40.0206.160-KKB	BT 40	6	25	133	160
HEI.B40.0206.200-KKB	BT 40	6	25	173	200
HEI.B40.0208.50-KKB	BT 40	8	28	23	50
HEI.B40.0208.100-KKB	BT 40	8	28	73	100
HEI.B40.0208.130-KKB	BT 40	8	28	103	130
HEI.B40.0208.160-KKB	BT 40	8	28	133	160
HEI.B40.0208.200-KKB	BT 40	8	28	173	200
HEI.B40.0210.63-KKB	BT 40	10	35	36	63
HEI.B40.0210.100-KKB	BT 40	10	35	73	100
HEI.B40.0210.130-KKB	BT 40	10	35	103	130
HEI.B40.0210.160-KKB	BT 40	10	35	133	160
HEI.B40.0210.200-KKB	BT 40	10	35	173	200
HEI.B40.0212.63-KKB	BT 40	12	42	36	63
HEI.B40.0212.100-KKB	BT 40	12	42	73	100
HEI.B40.0212.130-KKB	BT 40	12	42	103	130
HEI.B40.0212.160-KKB	BT 40	12	42	133	160
HEI.B40.0212.200-KKB	BT 40	12	42	173	200
HEI.B40.0214.63-KKB	BT 40	14	45	36	63
HEI.B40.0214.100-KKB	BT 40	14	45	73	100
HEI.B40.0214.130-KKB	BT 40	14	45	103	130
HEI.B40.0214.160-KKB	BT 40	14	45	133	160
HEI.B40.0214.200-KKB	BT 40	14	45	173	200

BT END MILL HOLDER DIN 6359

heikenei.com

FOR WELDON DIN 1835-B WITH COOLANT KKB

DIN ISO 7388-2 AD (JIS B 6339 MAS 403 BT)

FRÄSERAUFNAHME DIN 6359 ZYLINDERSCHÄFTE DIN 1835-B MIT KÜHLMITTEL BOHRUNG

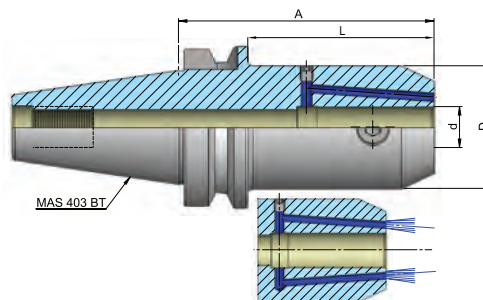

JIS B
6339

G 2.5
25.000
MIN

COOLANT

FORM
AD

ISO
7388-2



Artikelbezeichnung Item Code	Kegel Cone	d	D	L	A
HEI.B40.0216.63-KKB	BT 40	16	48	36	63
HEI.B40.0216.100-KKB	BT 40	16	48	73	100
HEI.B40.0216.130-KKB	BT 40	16	48	103	130
HEI.B40.0216.160-KKB	BT 40	16	48	133	160
HEI.B40.0216.200-KKB	BT 40	16	48	173	200
HEI.B40.0218.63-KKB	BT 40	18	50	36	63
HEI.B40.0218.100-KKB	BT 40	18	50	73	100
HEI.B40.0218.160-KKB	BT 40	18	50	133	160
HEI.B40.0218.200-KKB	BT 40	18	50	173	200
HEI.B40.0220.63-KKB	BT 40	20	52	36	63
HEI.B40.0220.100-KKB	BT 40	20	52	73	100
HEI.B40.0220.130-KKB	BT 40	20	52	103	130
HEI.B40.0220.160-KKB	BT 40	20	52	133	160
HEI.B40.0220.200-KKB	BT 40	20	52	173	200
HEI.B40.0225.90-KKB	BT 40	25	63	63	90
HEI.B40.0225.130-KKB	BT 40	25	63	103	130
HEI.B40.0225.160-KKB	BT 40	25	63	133	160
HEI.B40.0225.200-KKB	BT 40	25	63	173	200
HEI.B40.0232.100-KKB	BT 40	32	72	73	100
HEI.B40.0232.130-KKB	BT 40	32	72	103	130
HEI.B40.0232.160-KKB	BT 40	32	72	133	160
HEI.B40.0232.200-KKB	BT 40	32	72	173	200
HEI.B40.0240.120-KKB	BT 40	40	80	93	120
HEI.B40.0240.160-KKB	BT 40	40	80	133	160

BT SHELL MILL HOLDER WITH DRIVING SLOT & COOLANT

DIN ISO 7388-2 AD (JIS B 6339 MAS 403 BT)

QUERNUT-AUFSTECKFRÄSDORN DIN 6357 MIT VERGRÖSSERTEM
BUNDDURCHMESSER MIT KÜHLMITTEL

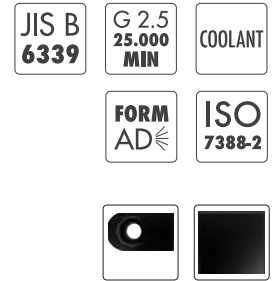
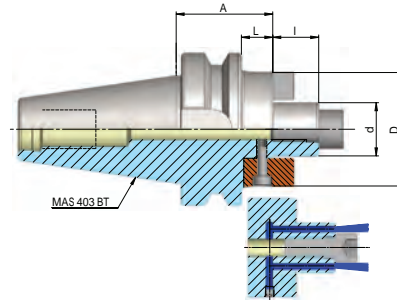

Artikelbezeichnung Item Code	Produktname Product name	d	D	L	A
HEI.B30.0316.40	BT 30 16 - 40	16	38	18	40
HEI.B30.0322.40	BT 30 22 - 40	22	48	18	40
HEI.B30.0327.40	BT 30 27 - 40	27	58	18	40
HEI.B30.0332.50	BT 30 32 - 50	32	78	28	50
HEI.B40.0316.40	BT 40 16 - 40	16	38	13	40
HEI.B40.0316.100	BT 40 16 - 100	16	38	73	100
HEI.B40.0316.130	BT 40 16 - 130	16	38	103	130
HEI.B40.0316.160	BT 40 16 - 160	16	38	133	160
HEI.B40.0322.40	BT 40 22 - 40	22	48	13	40
HEI.B40.0322.100	BT 40 22 - 100	22	48	73	100
HEI.B40.0322.130	BT 40 22 - 130	22	48	103	130
HEI.B40.0322.160	BT 40 22 - 160	22	48	133	160
HEI.B40.0327.40	BT 40 27 - 40	27	58	13	40
HEI.B40.0327.100	BT 40 27 - 100	27	58	73	100
HEI.B40.0327.130	BT 40 27 - 130	27	58	103	130
HEI.B40.0327.160	BT 40 27 - 160	27	58	133	160
HEI.B40.0332.50	BT 40 32 - 50	32	78	23	50
HEI.B40.0332.100	BT 40 32 - 100	32	78	73	100
HEI.B40.0332.130	BT 40 32 - 130	32	78	103	130
HEI.B40.0332.160	BT 40 32 - 160	32	78	133	160
HEI.B40.0340.50	BT 40 40 - 50	40	88	23	50
HEI.B40.0340.100	BT 40 40 - 100	40	88	73	100
HEI.B40.0340.130	BT 40 40 - 130	40	88	103	130
HEI.B40.0340.160	BT 40 40 - 160	40	88	133	160

BT SHELL MILL HOLDER DIN 6357

heikenei.com

FOR FACE MILLS WITH DRIVING SLOT & COOLANT

DIN ISO 7388-2 AD (JIS B 6339 MAS 403 BT)

QUERNUT-AUFSTECKFRÄSDORN DIN 6357 MIT VERGRÖSSERTEM
BUNDDURCHMESSER MIT KÜHLMITTEL

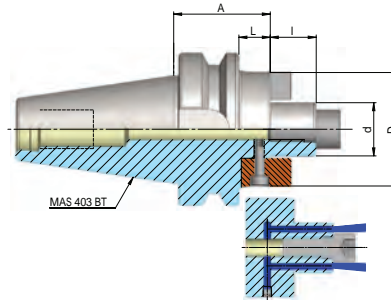

JIS B
6339

G 2.5
25.000
MIN

COOLANT

FORM
AD

ISO
7388-2



Artikelbezeichnung Item Code	Produktname Product name	d	D	L	A
HEI.B50.0316.55	BT 50 16 - 55	16	38	17	55
HEI.B50.0316.100	BT 50 16 - 100	16	38	62	100
HEI.B50.0316.130	BT 50 16 - 130	16	38	92	130
HEI.B50.0316.160	BT 50 16 - 160	16	38	122	160
HEI.B50.0322.55	BT 50 22 - 55	22	48	17	55
HEI.B50.0322.100	BT 50 22 - 100	22	48	62	100
HEI.B50.0322.130	BT 50 22 - 130	22	48	92	130
HEI.B50.0322.160	BT 50 22 - 160	22	48	122	160
HEI.B50.0327.55	BT 50 27 - 55	27	58	17	55
HEI.B50.0327.100	BT 50 27 - 100	27	58	62	100
HEI.B50.0327.130	BT 50 27 - 130	27	58	92	130
HEI.B50.0327.160	BT 50 27 - 160	27	58	122	160
HEI.B50.0332.55	BT 50 32 - 55	32	78	17	55
HEI.B50.0332.100	BT 50 32 - 100	32	78	62	100
HEI.B50.0332.130	BT 50 32 - 130	32	78	92	130
HEI.B50.0332.160	BT 50 32 - 160	32	78	122	160
HEI.B50.0340.55	BT 50 40 - 55	40	88	17	55
HEI.B50.0340.100	BT 50 40 - 100	40	88	62	100
HEI.B50.0340.130	BT 50 40 - 130	40	88	92	130
HEI.B50.0340.160	BT 50 40 - 160	40	88	122	160
HEI.B50.0360.80	BT 50 60 - 80	60	128	42	80

BT COMBI SHELL MILL HOLDER

DIN ISO 7388-2 AD (JIS B 6339 MAS 403 BT)

KOMBI-AUFSTECKFRÄSDORN DIN 6358 KÜHLMITTEL

HEIKENEI[®]

wir produzieren industrielle Lösungen

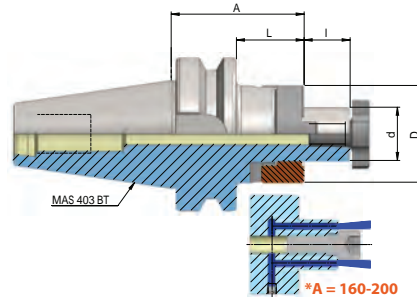

JIS B
6339

G 2.5
**25.000
MIN**

FORM
AD

ISO
7388-2



Artikelbezeichnung Item Code	Produktname Product name	Spannbereich Capacity	D	L	A
HEI.B30.0416.45	BT 30 16 - 45	16	32	23	45
HEI.B30.0422.47	BT 30 22 - 47	22	40	25	47
HEI.B30.0427.49	BT 30 27 - 49	27	48	27	49
HEI.B30.0432.52	BT 30 32 - 52	32	58	30	52
HEI.B40.0416.55	BT 40 16 - 55	16	32	28	55
HEI.B40.0416.100	BT 40 16 - 100	16	32	73	100
HEI.B40.0416.130	BT 40 16 - 130	16	32	103	130
HEI.B40.0416.160	BT 40 16 - 160	16	32	133	160
HEI.B40.0422.55	BT 40 22 - 55	22	40	28	55
HEI.B40.0422.100	BT 40 22 - 100	22	40	73	100
HEI.B40.0422.130	BT 40 22 - 130	22	40	103	130
HEI.B40.0422.160	BT 40 22 - 160	22	40	133	160
HEI.B40.0427.55	BT 40 27 - 55	27	48	28	55
HEI.B40.0427.100	BT 40 27 - 100	27	48	73	100
HEI.B40.0427.130	BT 40 27 - 130	27	48	103	130
HEI.B40.0427.160	BT 40 27 - 160	27	48	133	160
HEI.B40.0432.60	BT 40 32 - 60	32	58	33	60
HEI.B40.0432.100	BT 40 32 - 100	32	58	73	100
HEI.B40.0432.130	BT 40 32 - 130	32	58	103	130
HEI.B40.0432.160	BT 40 32 - 160	32	58	133	160
HEI.B40.0440.60	BT 40 40 - 60	40	70	33	60
HEI.B40.0440.100	BT 40 40 - 100	40	70	73	100

BT COMBI SHELL MILL HOLDER

DIN ISO 7388-2 AD (JIS B 6339 MAS 403 BT)

KOMBI-AUFSTECKFRÄSDORN DIN 6358 KÜHLMITTEL

heikenei.com

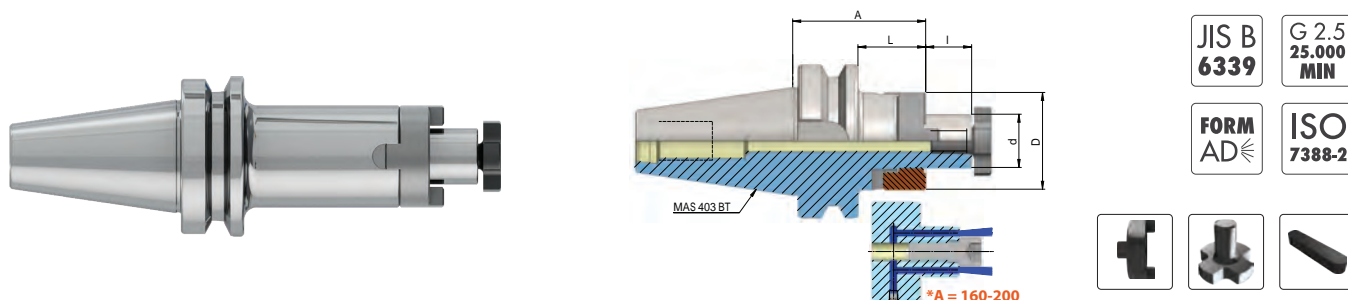

Artikelbezeichnung Item Code	Produktname Product name	Spannbereich Capacity	D	L	A
HEI.B50.0416.70	BT 50 16 - 70	16	32	32	70
HEI.B50.0416.100	BT 50 16 - 100	16	32	62	100
HEI.B50.0416.130	BT 50 16 - 130	16	32	92	130
HEI.B50.0416.160	BT 50 16 - 160	16	32	122	160
HEI.B50.0416.200	BT 50 16 - 200	16	32	162	200
HEI.B50.0422.70	BT 50 22 - 70	22	40	32	70
HEI.B50.0422.100	BT 50 22 - 100	22	40	62	100
HEI.B50.0422.130	BT 50 22 - 130	22	40	92	130
HEI.B50.0422.160	BT 50 22 - 160	22	40	122	160
HEI.B50.0422.200	BT 50 22 - 200	22	40	162	200
HEI.B50.0427.70	BT 50 27 - 70	27	48	32	70
HEI.B50.0427.100	BT 50 27 - 100	27	48	62	100
HEI.B50.0427.130	BT 50 27 - 130	27	48	92	130
HEI.B50.0427.160	BT 50 27 - 160	27	48	122	160
HEI.B50.0427.200	BT 50 27 - 200	27	48	162	200
HEI.B50.0432.70	BT 50 32 - 70	32	58	32	70
HEI.B50.0432.100	BT 50 32 - 100	32	58	62	100
HEI.B50.0432.130	BT 50 32 - 130	32	58	92	130
HEI.B50.0432.160	BT 50 32 - 160	32	58	122	160
HEI.B50.0432.200	BT 50 32 - 200	32	58	162	200
HEI.B50.0440.70	BT 50 40 - 70	40	70	32	70
HEI.B50.0440.100	BT 50 40 - 100	40	70	62	100
HEI.B50.0440.130	BT 50 40 - 130	40	70	92	130
HEI.B50.0440.160	BT 50 40 - 160	40	70	122	160
HEI.B50.0440.200	BT 50 40 - 200	40	70	162	200

BT MORSE TAPER ADAPTOR

DIN ISO 7388-2 AD (JIS B 6339 MAS 403 BT)

ZWISCHENHÜLSE FÜR MK MIT AUSTREIBBLAPPEN DIN 6383

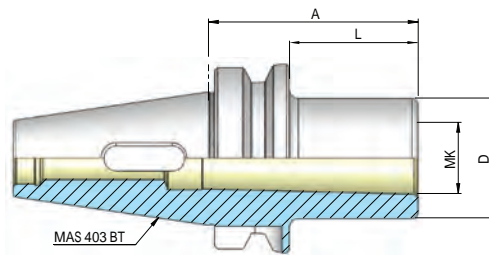
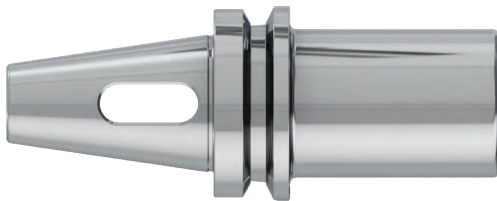

Artikelbezeichnung Item Code	Produktname Product name	MK	D	L	A
HEI.B30.0501.45	BT 30 1 - 45	1	25	23	45
HEI.B30.0502.60	BT 30 2 - 60	2	32	38	60
HEI.B30.0503.75	BT 30 3 - 75	3	40	53	75
HEI.B40.0501.50	BT 40 1 - 50	1	25	23	50
HEI.B40.0502.50	BT 40 2 - 50	2	32	23	50
HEI.B40.0503.70	BT 40 3 - 70	3	40	43	70
HEI.B40.0504.95	BT 40 4 - 95	4	48	68	95
HEI.B50.0501.45	BT 50 1 - 45	1	25	7	45
HEI.B50.0502.60	BT 50 2 - 60	2	32	22	60
HEI.B50.0503.65	BT 50 3 - 65	3	40	27	65
HEI.B50.0504.95	BT 50 4 - 95	4	48	57	95
HEI.B50.0505.105	BT 50 5 - 105	5	63	67	105

BT MORSE TAPER ADAPTOR - WITH THREAD

heikenei.com

DIN ISO 7388-2 A (JIS B 6339 MAS 403 BT)

ZWISCHENHÜLSE FÜR MK MIT ANZUGSGEWINDE DIN 6364

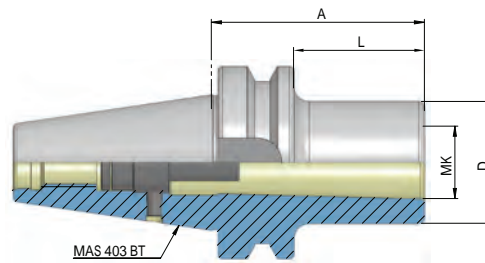

Artikelbezeichnung Item Code	Produktname Product name	MK	D	L	A
HEI.B40.0601.50	BT 40 1 - 50	1	25	23	50
HEI.B40.0602.50	BT 40 2 - 50	2	32	23	50
HEI.B40.0603.70	BT 40 3 - 70	3	40	43	70
HEI.B40.0604.95	BT 40 4 - 95	4	48	68	95
HEI.B50.0601.45	BT 50 1 - 45	1	25	7	45
HEI.B50.0602.60	BT 50 2 - 60	2	32	22	60
HEI.B50.0603.65	BT 50 3 - 65	3	40	27	65
HEI.B50.0604.70	BT 50 4 - 70	4	48	32	70
HEI.B50.0605.100	BT 50 5 - 100	5	63	62	100

BT REDUCING ADAPTER

DIN ISO 7388-2 A (JIS B 6339 MAS 403 BT)
 ZWISCHENHÜLSE/REDUZIERHÜLSE

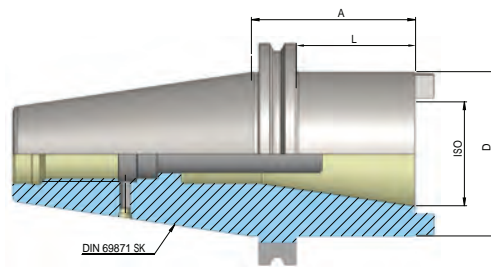

Artikelbezeichnung Item Code	Produktname Product name	ADAPT	D	L	A
HEI.B40.0730.60	BT 40 30 - 60	SK30 - BT30	50	33	60
HEI.B40.0740.100	BT 40 40 - 100	SK40 - BT40	63	73	100
HEI.B50.0740.70	BT 50 40 - 70	SK40 - BT40	70	32	70
HEI.B50.0750.120	BT 50 50 - 120	SK50 - BT50	97	82	120

BT ARBORS FOR MODULAR (SCREW TYPE) INDEXABLE END MILLS

heikenei.com

DIN ISO 7388-2 AD (JIS B 6339 MAS 403 BT)

FRÄSAUFNAHME FÜR EINSCHRAUBFRÄSER

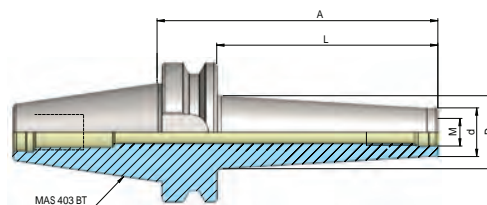
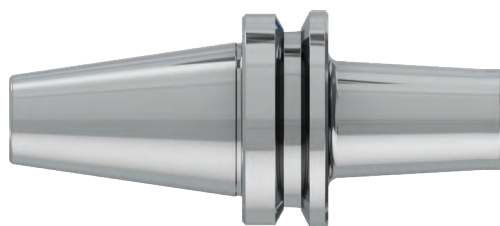

JIS B
6339

G 2.5
25.000
MIN

FORM
AD

ISO
7388-2

Artikelbezeichnung Item Code	Produktname Product name	Spannbereich Capacity	d	D	L	A
HEI.B40.0806.52	BT 40 M6 - 52	M6	10	13	25	52
HEI.B40.0806.77	BT 40 M6 - 77	M6	10	28	50	77
HEI.B40.0806.102	BT 40 M6 - 102	M6	10	28	75	102
HEI.B40.0808.52	BT 40 M8 - 52	M8	13	15	25	52
HEI.B40.0808.77	BT 40 M8 - 77	M8	13	23	50	77
HEI.B40.0808.102	BT 40 M8 - 102	M8	13	23	75	102
HEI.B40.0808.127	BT 40 M8 - 127	M8	13	25	100	127
HEI.B40.0810.52	BT 40 M10 - 52	M10	18	20	25	52
HEI.B40.0810.77	BT 40 M10 - 77	M10	18	23	50	77
HEI.B40.0810.102	BT 40 M10 - 102	M10	18	26	75	102
HEI.B40.0810.127	BT 40 M10 - 127	M10	18	29	100	127
HEI.B40.0810.152	BT 40 M10 - 152	M10	18	32	125	152
HEI.B40.0812.52	BT 40 M12 - 52	M12	21	24	25	52
HEI.B40.0812.77	BT 40 M12 - 77	M12	21	27	50	77
HEI.B40.0812.102	BT 40 M12 - 102	M12	21	30	75	102
HEI.B40.0812.127	BT 40 M12 - 127	M12	21	33	100	127
HEI.B40.0812.152	BT 40 M12 - 152	M12	21	36	125	152
HEI.B40.0816.27	BT 40 M16 - 27	M16	29	29	5	27
HEI.B40.0816.52	BT 40 M16 - 52	M16	29	29	25	52
HEI.B40.0816.77	BT 40 M16 - 77	M16	29	32	50	77
HEI.B40.0816.102	BT 40 M16 - 102	M16	29	34	75	102
HEI.B40.0816.127	BT 40 M16 - 127	M16	29	37	100	127
HEI.B40.0816.152	BT 40 M16 - 152	M16	29	40	125	152

BT ARBORS FOR MODULAR (SCREW TYPE) INDEXABLE END MILLS

DIN ISO 7388-2 AD (JIS B 6339 MAS 403 BT)
FRÄSAUFNAHME FÜR EINSCHRAUBFRÄSER

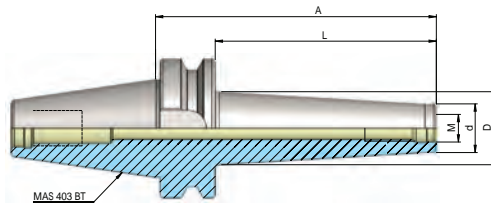
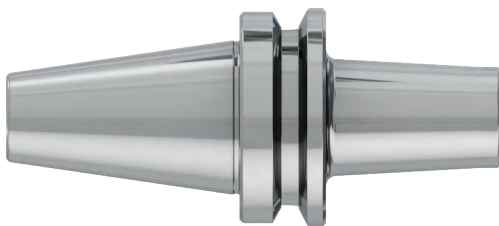

Artikelbezeichnung Item Code	Produktname Product name	Spannbereich Capacity	d	D	L	A
HEI.B50.0808.88	BT 50 M8 - 88	M8	13	23	50	88
HEI.B50.0808.138	BT 50 M8 - 138	M8	13	25	100	138
HEI.B50.0808.188	BT 50 M8 - 188	M8	13	30	150	188
HEI.B50.0810.88	BT 50 M10 - 88	M10	18	23	50	88
HEI.B50.0810.138	BT 50 M10 - 138	M10	18	32	100	138
HEI.B50.0810.188	BT 50 M10 - 188	M10	18	36	150	188
HEI.B50.0812.88	BT 50 M12 - 88	M12	21	24	50	88
HEI.B50.0812.138	BT 50 M12 - 138	M12	21	33	100	138
HEI.B50.0812.188	BT 50 M12 - 188	M12	21	40	150	188
HEI.B50.0816.88	BT 50 M16 - 88	M16	29	34	50	88
HEI.B50.0816.138	BT 50 M16 - 138	M16	29	36	100	138
HEI.B50.0816.188	BT 50 M16 - 188	M16	29	42	150	188

BT INDEXABLE DRILLS HOLDER E1

JIS B 6339 (DIN ISO 7388-2) MAS 403 BT
BOHRERHALTER FÜR WENDEPLATTENBOHRER E1

heikenei.com

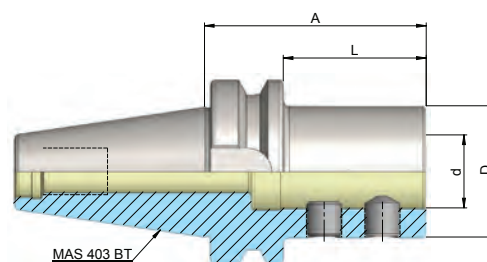
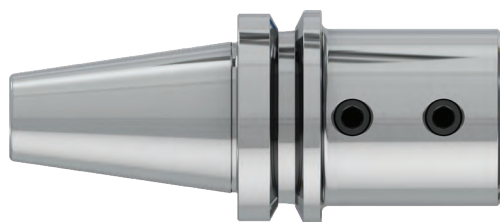

JIS B
6339

G 2.5
25.000
MIN

FORM
AD

ISO
7388-2



Artikelbezeichnung Item Code	Produktname Product name	Spannbereich Capacity	D	L	A
HEI.B40.1420.72	BT 40 20 - 72 - E1	20	40	45	72
HEI.B40.1425.76	BT 40 25 - 76 - E1	25	45	49	76
HEI.B40.1432.80	BT 40 32 - 80 - E1	32	52	53	80
HEI.B50.1420.90	BT 50 20 - 90 - E1	20	40	52	90
HEI.B50.1425.90	BT 50 25 - 90 - E1	25	45	52	90
HEI.B50.1432.90	BT 50 32 - 90 - E1	32	52	52	90
HEI.B50.1440.100	BT 50 40 - 100 - E1	40	60	62	100

BT BLANK BAR

DIN ISO 7388-2 A (JIS B 6339 MAS 403 BT)

BOHRSTANGENROHLING ZUR ANFERTIGUNG VON SONDERWERKZEUGEN

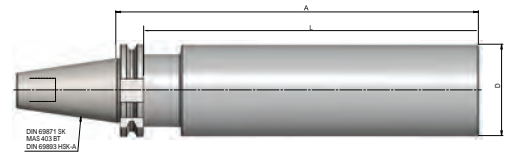

Artikelbezeichnung Item Code	Produktname Product name	D	A
HEI.B40.1063.250	BT 40 63 - 250	63	250
HEI.B50.1097.315	BT 50 97- 315	97	315

SK

heikenei.com

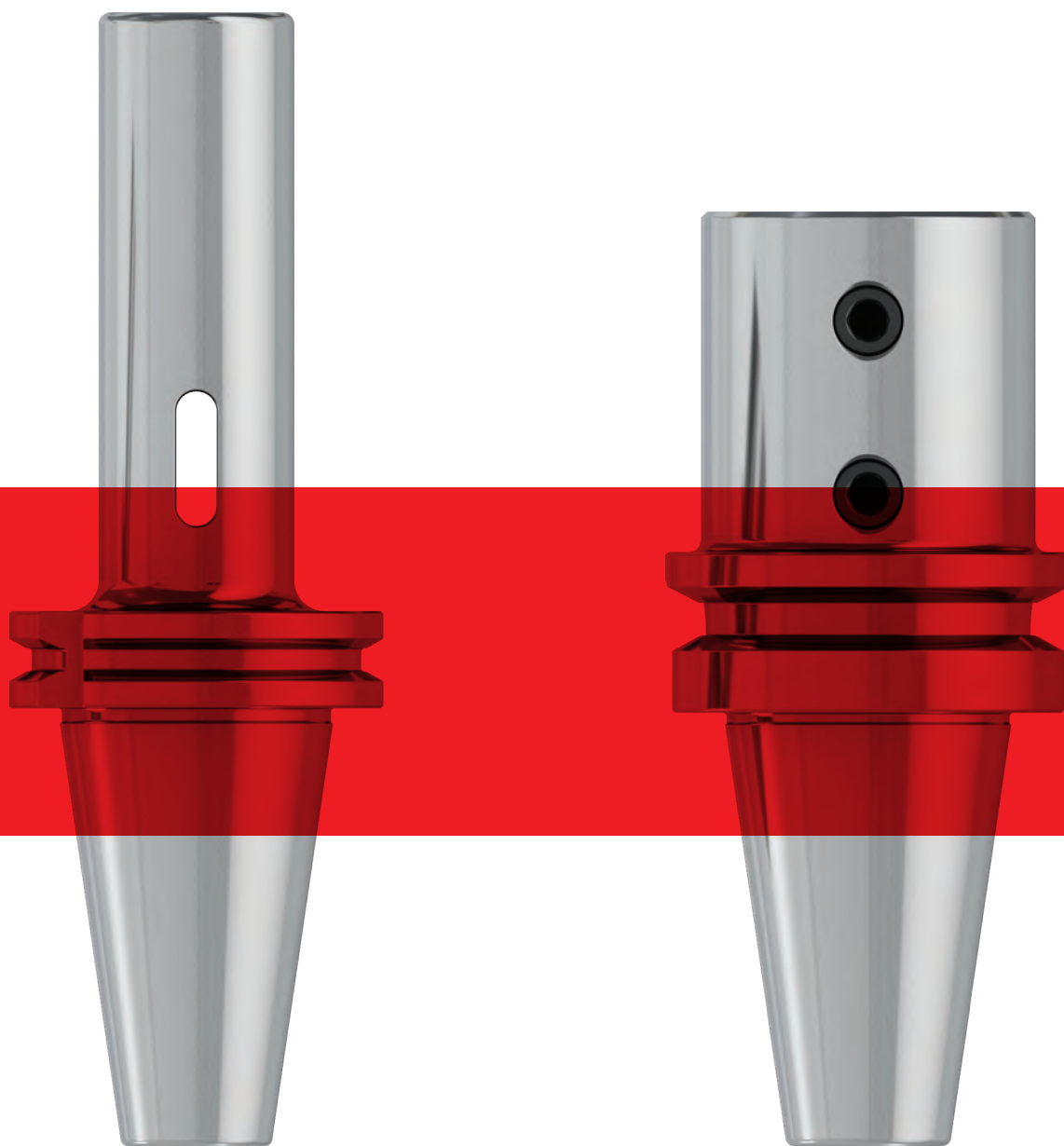



PG. 30 - 55

SK HOLDING SYSTEM DIMENSIONS

DIN 69871 SK (DIN ISO 7388-1)

heikenei.com

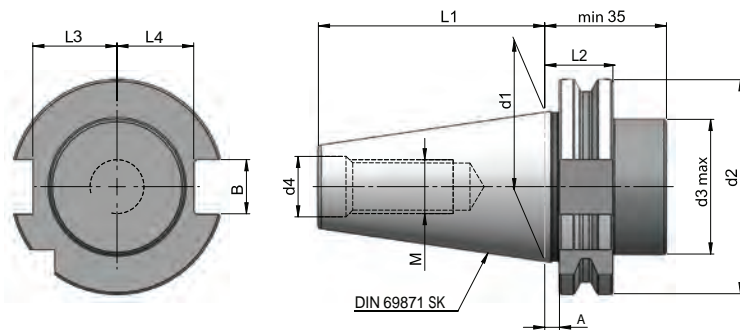

Dimensions	Ø d1	Ø d2	Ø d3	Ø d4	M	A	L1	L2	L3	L4	B
SK30	31,75	50	45	13	M12	3,2	47,8	19,1	19	16,4	16,1
SK40	44,45	63,55	50	17	M16	3,2	68,4	19,1	25	22,8	16,1
SK50	69,85	97,5	80	25	M24	3,2	101,8	19,1	37,7	35,5	25,7

SK COLLET CHUCKS FOR COLLETS DIN 6499 ER

DIN ISO 7388-1 AD (DIN 69871) SK
SPANNZANGENFUTTER DIN 6499 ER

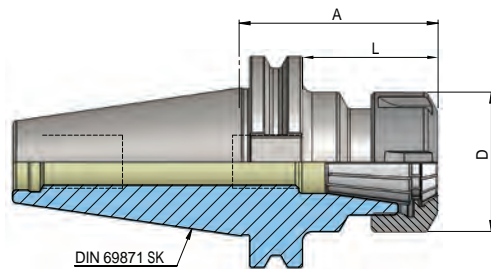
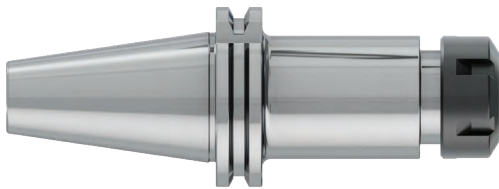

DIN 69871 G 2.5 25.000 MIN

FORM AD ISO 7388-1



Artikelbezeichnung Item Code	Produktname Product name	Spannbereich Capacity	D	L	A
HEI.S30.0116.70	SK 30 ER 16 - 70	1 - 10	28	51	70
HEI.S30.0116.100	SK 30 ER 16 - 100	1 - 10	28	81	100
HEI.S30.0125.70	SK 30 ER 25 - 70	2 - 16	42	51	70
HEI.S30.0125.100	SK 30 ER 25 - 100	2 - 16	42	81	100
HEI.S30.0132.70	SK 30 ER 32 - 70	2 - 20	50	51	70
HEI.S30.0132.100	SK 30 ER 32 - 100	2 - 20	50	81	100
HEI.S30.0140.70	SK 30 ER 40 - 70	3 - 26	63	51	70
HEI.S40.0116.63	SK 40 ER 16 - 63	1 - 10	28	44	63
HEI.S40.0116.100	SK 40 ER 16 - 100	1 - 10	28	81	100
HEI.S40.0116.130	SK 40 ER 16 - 130	1 - 10	28	111	130
HEI.S40.0116.160	SK 40 ER 16 - 160	1 - 10	28	141	160
HEI.S40.0125.60	SK 40 ER 25 - 60	2 - 16	42	41	60
HEI.S40.0125.100	SK 40 ER 25 - 100	2 - 16	42	81	100
HEI.S40.0125.130	SK 40 ER 25 - 130	2 - 16	42	111	130
HEI.S40.0125.160	SK 40 ER 25 - 160	2 - 16	42	141	160
HEI.S40.0132.70	SK 40 ER 32 - 70	2 - 20	50	51	70
HEI.S40.0132.100	SK 40 ER 32 - 100	2 - 20	50	81	100
HEI.S40.0132.130	SK 40 ER 32 - 130	2 - 20	50	111	130
HEI.S40.0132.160	SK 40 ER 32 - 160	2 - 20	50	141	160
HEI.S40.0140.80	SK 40 ER 40 - 80	3 - 26	63	61	80
HEI.S40.0140.100	SK 40 ER 40 - 100	3 - 26	63	81	100
HEI.S40.0140.130	SK 40 ER 40 - 130	3 - 26	63	111	130
HEI.S40.0140.160	SK 40 ER 40 - 160	3 - 26	63	141	160

SK COLLET CHUCKS FOR COLLETS DIN 6499 ER

DIN ISO 7388-1 AD (DIN 69871) SK
SPANZANGENFUTTER DIN 6499 ER

heikenei.com

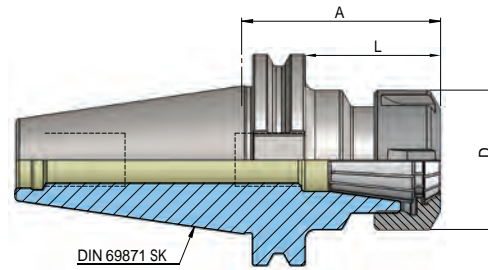
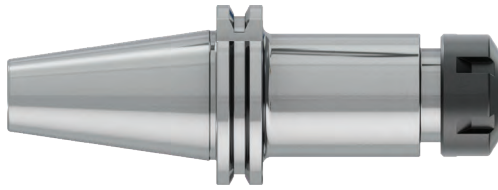

DIN
69871

G 2.5
25.000
MIN

FORM
AD

ISO
7388-1



Artikelbezeichnung Item Code	Produktname Product name	Spannbereich Capacity	D	L	A
HEI.S50.0116.63	SK 50 ER 16 - 63	1 - 10	28	44	63
HEI.S50.0116.100	SK 50 ER 16 - 100	1 - 10	28	81	100
HEI.S50.0116.130	SK 50 ER 16 - 130	1 - 10	28	111	130
HEI.S50.0116.160	SK 50 ER 16 - 160	1 - 10	28	141	160
HEI.S50.0125.60	SK 50 ER 25 - 60	2 - 16	42	41	60
HEI.S50.0125.100	SK 50 ER 25 - 100	2 - 16	42	81	100
HEI.S50.0125.130	SK 50 ER 25 - 130	2 - 16	42	111	130
HEI.S50.0125.160	SK 50 ER 25 - 160	2 - 16	42	141	160
HEI.S50.0132.70	SK 50 ER 32 - 70	2 - 20	50	51	70
HEI.S50.0132.100	SK 50 ER 32 - 100	2 - 20	50	81	100
HEI.S50.0132.130	SK 50 ER 32 - 130	2 - 20	50	111	130
HEI.S50.0132.160	SK 50 ER 32 - 160	2 - 20	50	141	160
HEI.S50.0140.80	SK 50 ER40 - 80	3 - 26	63	61	80
HEI.S50.0140.100	SK 50 ER40 - 100	3 - 26	63	81	100
HEI.S50.0140.130	SK 50 ER40 - 130	3 - 26	63	111	130
HEI.S50.0140.160	SK 50 ER40 - 160	3 - 26	63	141	160

SK COLLET CHUCKS DIN 6391 FOR COLLETS DIN 6388-OZ

DIN ISO 7388-1 AD (DIN 69871) SK

SPANNFUTTER DIN 6391 FÜR SPANNZANGEN DIN 6388-OZ

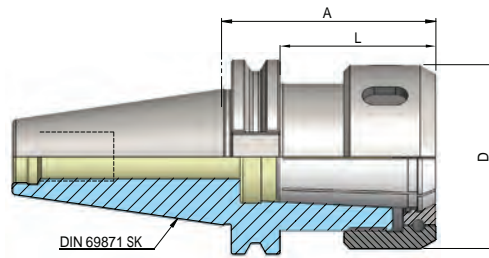
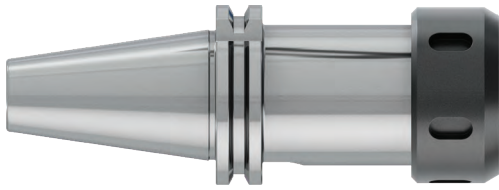

Artikelbezeichnung Item Code	Produktname Product name	Spannbereich Capacity	D	L	A
HEI.S30.0116.60.OZ	SK 30 E 416 - 60	2 - 16	43	41	60
HEI.S30.0125.80.OZ	SK 30 E 462 - 80	2 - 25	60	61	80
HEI.S40.0116.70.OZ	SK 40 E 416 - 70	2 - 16	43	51	70
HEI.S40.0116.100.OZ	SK 40 E 416 - 100	2 - 16	43	81	100
HEI.S40.0125.70.OZ	SK 40 E 462 - 70	2 - 25	60	51	70
HEI.S40.0125.100.OZ	SK 40 E 462 - 100	2 - 25	60	81	100
HEI.S40.0132.90.OZ	SK 40 E 467 - 90	3 - 32	72	71	90
HEI.S50.0116.70.OZ	SK 50 E 416 - 70	2 - 16	43	51	70
HEI.S50.0125.70.OZ	SK 50 E 462 - 70	2 - 25	60	51	70
HEI.S50.0132.80.OZ	SK 50 E 467 - 80	3 - 32	72	61	80

SK COLLET CHUCKS FOR COLLETS

heikenei.com

DIN 6499 ER MINI

DIN ISO 7388-1 AD (DIN 69871) SK

SPANNZANGENFUTTER DIN 6499 ER MINI

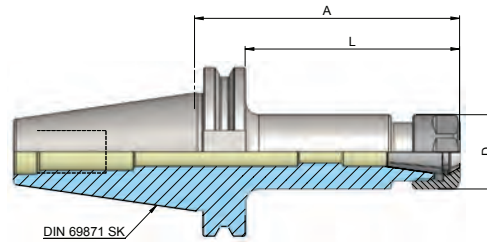
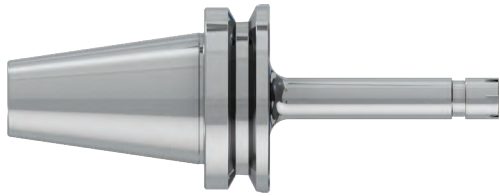

DIN
69871

G 2.5
25.000
MIN

FORM
AD

ISO
7388-1



Artikelbezeichnung Item Code	Produktname Product name	Spannbereich Capacity	D	L	A
HEI.S40.0111.100M	SK 40 ER 11 100 - M	1 - 7	16	81	100
HEI.S40.0111.130M	SK 40 ER 11 130 - M	1 - 7	16	111	130
HEI.S40.0111.160M	SK 40 ER 11 160 - M	1 - 7	16	141	160
HEI.S40.0116.100M	SK 40 ER 16 100 - M	1 - 10	22	81	100
HEI.S40.0116.130M	SK 40 ER 16 130 - M	1 - 10	22	111	130
HEI.S40.0116.160M	SK 40 ER 16 160 - M	1 - 10	22	141	160
HEI.S50.0116.100M	SK 50 ER 16 100 - M	1 - 10	22	81	100
HEI.S50.0116.130M	SK 50 ER 16 130 - M	1 - 10	22	111	130
HEI.S50.0116.160M	SK 50 ER 16 160 - M	1 - 10	22	141	160

SK END MILL HOLDER DIN 6359 FOR WELDON DIN 1835-B

DIN ISO 7388-1 AD (DIN 69871) SK

FRASERAUFNAHME DIN 6359 ZYLINDERSCHAFTE DIN 1835-B

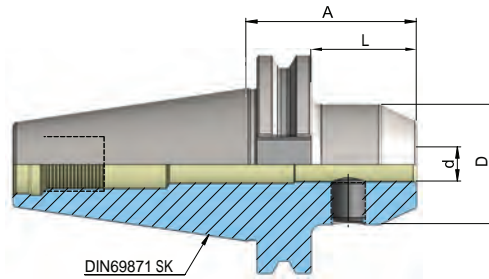
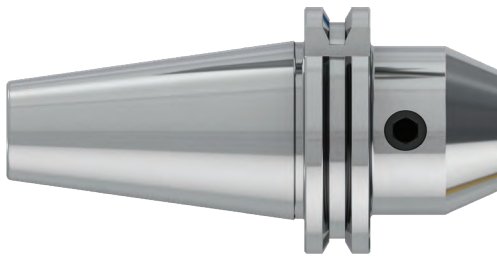

Artikelbezeichnung Item Code	Produktname Product name	Spannbereich Capacity	D	L	A
HEI.S30.0206.50	SK 30 6 - 50	6	25	31	50
HEI.S30.0208.50	SK 30 8 - 50	8	28	31	50
HEI.S30.0210.50	SK 30 10 - 50	10	35	31	50
HEI.S30.0212.50	SK 30 12 - 50	12	42	31	50
HEI.S30.0214.63	SK 30 14 - 63	14	44	44	63
HEI.S30.0216.63	SK 30 16 - 63	16	48	44	63
HEI.S30.0218.63	SK 30 18 - 63	18	50	44	63
HEI.S30.0220.70	SK 30 20 - 70	20	52	51	70
HEI.S40.0206.50	SK 40 6 - 50	6	25	31	50
HEI.S40.0206.100	SK 40 6 - 100	6	25	81	100
HEI.S40.0206.130	SK 40 6 - 130	6	25	111	130
HEI.S40.0206.160	SK 40 6 - 160	6	25	141	160
HEI.S40.0208.50	SK 40 8 - 50	8	28	31	50
HEI.S40.0208.100	SK 40 8 - 100	8	28	81	100
HEI.S40.0208.130	SK 40 8 - 130	8	28	111	130
HEI.S40.0208.160	SK 40 8 - 160	8	28	141	160
HEI.S40.0210.50	SK 40 10 - 50	10	35	31	50
HEI.S40.0210.100	SK 40 10 - 100	10	35	81	100
HEI.S40.0210.130	SK 40 10 - 130	10	35	111	130
HEI.S40.0210.160	SK 40 10 - 160	10	35	141	160
HEI.S40.0212.50	SK 40 12 - 50	12	42	31	50
HEI.S40.0212.100	SK 40 12 - 100	12	42	81	100
HEI.S40.0212.130	SK 40 12 - 130	12	42	111	130
HEI.S40.0212.160	SK 40 12 - 160	12	42	141	160

SK END MILL HOLDER DIN 6359 FOR WELDON DIN 1835-B

heikenei.com

DIN ISO 7388-1 AD (DIN 69871) SK

FRASERAUFNAHME DIN 6359 ZYLINDERSCHAFFE DIN 1835-B

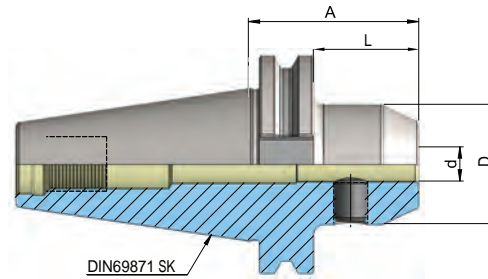

Artikelbezeichnung Item Code	Produktname Product name	Spannbereich Capacity	D	L	A
HEI.S40.0214.50	SK 40 14 - 50	14	45	31	50
HEI.S40.0214.100	SK 40 14 - 100	14	45	81	100
HEI.S40.0214.160	SK 40 14 - 160	14	45	141	160
HEI.S40.0216.35	SK 40 16 - 35	16	45	16	35
HEI.S40.0216.63	SK 40 16 - 63	16	48	44	63
HEI.S40.0216.100	SK 40 16 - 100	16	48	81	100
HEI.S40.0216.130	SK 40 16 - 130	16	48	111	130
HEI.S40.0216.160	SK 40 16 - 160	16	48	141	160
HEI.S40.0218.63	SK 40 18 - 63	18	50	44	63
HEI.S40.0218.100	SK 40 18 - 100	18	50	81	100
HEI.S40.0218.160	SK 40 18 - 160	18	50	141	160
HEI.S40.0220.35	SK 40 20 - 35	20	45	16	35
HEI.S40.0220.63	SK 40 20 - 63	20	52	44	63
HEI.S40.0220.100	SK 40 20 - 100	20	52	81	100
HEI.S40.0220.130	SK 40 20 - 130	20	52	111	130
HEI.S40.0220.160	SK 40 20 - 160	20	52	141	160
HEI.S40.0225.35	SK 40 25 - 35	25	45	16	35
HEI.S40.0225.100	SK 40 25 - 100	25	63	81	100
HEI.S40.0225.160	SK 40 25 - 160	25	63	141	160
HEI.S40.0232.65	SK 40 32 - 65	32	63	46	65
HEI.S40.0232.100	SK 40 32 - 100	32	72	81	100
HEI.S40.0232.160	SK 40 32 - 160	32	72	141	160
HEI.S40.0240.120	SK 40 40 - 120	40	80	101	120

SK END MILL HOLDER DIN 6359 FOR WELDON DIN 1835-B

DIN ISO 7388-1 AD (DIN 69871) SK

FRASERAUFNAHME DIN 6359 ZYLINDERSCHAFTE DIN 1835-B

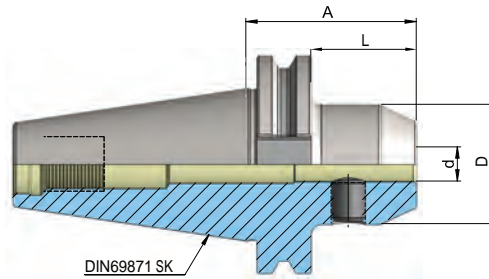

Artikelbezeichnung Item Code	Produktname Product name	Spannbereich Capacity	D	L	A
HEI.S50.0206.63	SK 50 6 - 63	6	25	44	63
HEI.S50.0206.100	SK 50 6 - 100	6	25	81	100
HEI.S50.0206.130	SK 50 6 - 130	6	25	111	130
HEI.S50.0206.160	SK 50 6 - 160	6	25	141	160
HEI.S50.0208.63	SK 50 8 - 63	8	28	44	63
HEI.S50.0208.100	SK 50 8 - 100	8	28	81	100
HEI.S50.0208.130	SK 50 8 - 130	8	28	111	130
HEI.S50.0208.160	SK 50 8 - 160	8	28	141	160
HEI.S50.0210.63	SK 50 10 - 63	10	35	44	63
HEI.S50.0210.100	SK 50 10 - 100	10	35	81	100
HEI.S50.0210.130	SK 50 10 - 130	10	35	111	130
HEI.S50.0210.160	SK 50 10 - 160	10	35	141	160
HEI.S50.0212.63	SK 50 12 - 63	12	42	44	63
HEI.S50.0212.100	SK 50 12 - 100	12	42	81	100
HEI.S50.0212.130	SK 50 12 - 130	12	42	111	130
HEI.S50.0212.160	SK 50 12 - 160	12	42	141	160
HEI.S50.0214.63	SK 50 14 - 63	14	45	44	63
HEI.S50.0214.100	SK 50 14 - 100	14	45	81	130
HEI.S50.0214.160	SK 50 14 - 160	14	45	141	160

SK END MILL HOLDER DIN 6359 FOR WELDON DIN 1835-B

heikenei.com

DIN ISO 7388-1 AD (DIN 69871) SK

FRASERAUFNAHME DIN 6359 ZYLINDERSCHAFT DIN 1835-B

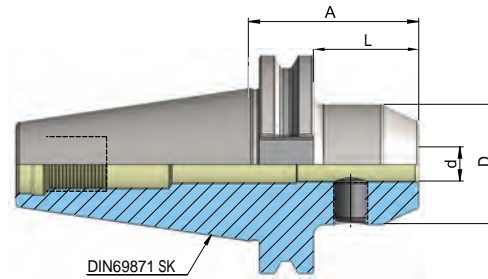
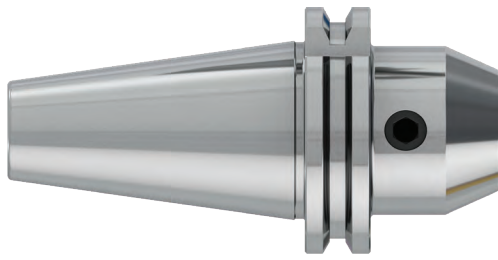

Artikelbezeichnung Item Code	Produktname Product name	Spannbereich Capacity	D	L	A
HEI.S50.0216.63	SK 50 16 - 63	16	48	44	63
HEI.S50.0216.100	SK 50 16 - 100	16	48	81	100
HEI.S50.0216.130	SK 50 16 - 130	16	48	111	130
HEI.S50.0216.160	SK 50 16 - 160	16	48	141	160
HEI.S50.0218.63	SK 50 18 - 63	18	50	44	63
HEI.S50.0218.100	SK 50 18 - 100	18	50	81	100
HEI.S50.0218.160	SK 50 18 - 160	18	50	141	160
HEI.S50.0220.63	SK 50 20 - 63	20	52	44	63
HEI.S50.0220.100	SK 50 20 - 100	20	52	81	100
HEI.S50.0220.130	SK 50 20 - 130	20	52	111	130
HEI.S50.0220.160	SK 50 20 - 160	20	52	141	160
HEI.S50.0225.80	SK 50 25 - 80	25	65	61	80
HEI.S50.0225.130	SK 50 25 - 130	25	65	111	130
HEI.S50.0225.160	SK 50 25 - 160	25	65	141	160
HEI.S50.0232.100	SK 50 32 - 100	32	72	81	100
HEI.S50.0232.160	SK 50 32 - 160	32	72	141	160
HEI.S50.0240.100	SK 50 40 - 100	40	80	81	100
HEI.S50.0240.160	SK 50 40 - 160	40	80	141	160

SK END MILL HOLDER DIN 6359 FOR WELDON DIN 1835-B WITH COOLANT KKB



DIN ISO 7388-1 AD (DIN 69871) SK

FRÄSERAUFNAHME DIN 6359 ZYLINDERSCHÄFTE DIN 1835-B MIT KÜHLMITTEL BOHRUNG

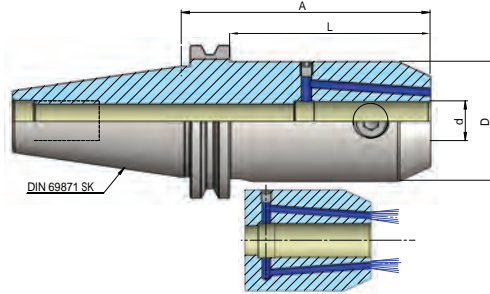
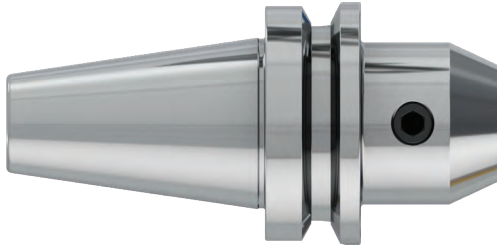

DIN
69871

G 2.5
25.000
MIN

COOLANT

FORM
AD

ISO
7388-1



Artikelbezeichnung Item Code	Kegel Cone	d	D	L	A
HEI.S40.0206.50-KKB	SK 40	6	25	31	50
HEI.S40.0206.100-KKB	SK 40	6	25	81	100
HEI.S40.0206.130-KKB	SK 40	6	25	111	130
HEI.S40.0206.160-KKB	SK 40	6	25	141	160
HEI.S40.0206.200-KKB	SK 40	6	25	181	200
HEI.S40.0208.50-KKB	SK 40	8	28	31	50
HEI.S40.0208.100-KKB	SK 40	8	28	81	100
HEI.S40.0208.130-KKB	SK 40	8	28	111	130
HEI.S40.0208.160-KKB	SK 40	8	28	141	160
HEI.S40.0208.200-KKB	SK 40	8	28	181	200
HEI.S40.0210.50-KKB	SK 40	10	35	31	50
HEI.S40.0210.100-KKB	SK 40	10	35	81	100
HEI.S40.0210.130-KKB	SK 40	10	35	111	130
HEI.S40.0210.160-KKB	SK 40	10	35	141	160
HEI.S40.0210.200-KKB	SK 40	10	35	181	200
HEI.S40.0212.50-KKB	SK 40	12	42	31	50
HEI.S40.0212.100-KKB	SK 40	12	42	81	100
HEI.S40.0212.130-KKB	SK 40	12	42	111	130
HEI.S40.0212.160-KKB	SK 40	12	42	141	160
HEI.S40.0212.200-KKB	SK 40	12	42	181	200
HEI.S40.0214.50-KKB	SK 40	14	45	31	50
HEI.S40.0214.100-KKB	SK 40	14	45	81	100
HEI.S40.0214.130-KKB	SK 40	14	45	111	130
HEI.S40.0214.160-KKB	SK 40	14	45	141	160
HEI.S40.0214.200-KKB	SK 40	14	45	181	200

SK END MILL HOLDER DIN 6359 FOR WELDON DIN 1835-B WITH COOLANT KKB

heikenei.com

DIN ISO 7388-1 AD (DIN 69871) SK

FRÄSERAUFNAHME DIN 6359 ZYLINDERSCHÄFTE DIN 1835-B MIT KÜHLMITTEL BOHRUNG

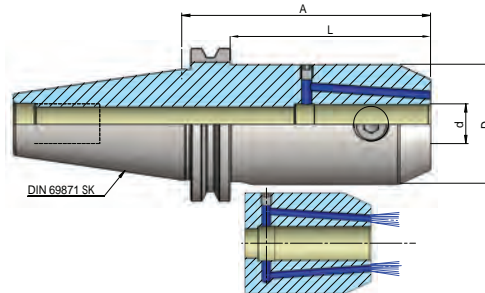
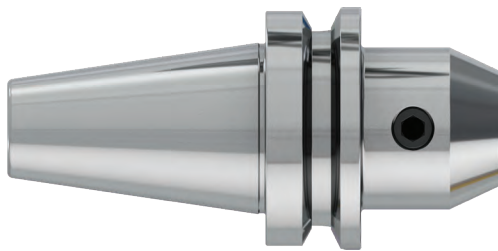

DIN
69871

G 2.5
25.000
MIN

COOLANT

FORM
AD

ISO
7388-1



Artikelbezeichnung Item Code	Kegel Cone	d	D	L	A
HEI.S40.0216.35-KKB	SK 40	16	45	16	35
HEI.S40.0216.63-KKB	SK 40	16	48	44	63
HEI.S40.0216.100-KKB	SK 40	16	48	81	100
HEI.S40.0216.130-KKB	SK 40	16	48	111	130
HEI.S40.0216.160-KKB	SK 40	16	48	141	160
HEI.S40.0216.200-KKB	SK 40	16	48	181	200
HEI.S40.0218.63-KKB	SK 40	18	50	44	63
HEI.S40.0218.100-KKB	SK 40	18	50	81	100
HEI.S40.0218.130-KKB	SK 40	18	50	111	130
HEI.S40.0218.160-KKB	SK 40	18	50	141	160
HEI.S40.0218.200-KKB	SK 40	18	50	181	200
HEI.S40.0220.35-KKB	SK 40	20	45	16	35
HEI.S40.0220.63-KKB	SK 40	20	52	44	63
HEI.S40.0220.100-KKB	SK 40	20	52	81	100
HEI.S40.0220.130-KKB	SK 40	20	52	111	130
HEI.S40.0220.160-KKB	SK 40	20	52	141	160
HEI.S40.0220.200-KKB	SK 40	20	52	181	200
HEI.S40.0225.100-KKB	SK 40	25	63	81	100
HEI.S40.0225.130-KKB	SK 40	25	63	111	130
HEI.S40.0225.160-KKB	SK 40	25	63	141	160
HEI.S40.0225.200-KKB	SK 40	25	63	181	200
HEI.S40.0232.100-KKB	SK 40	32	72	81	100
HEI.S40.0232.130-KKB	SK 40	32	72	111	130
HEI.S40.0232.160-KKB	SK 40	32	72	141	160
HEI.S40.0232.200-KKB	SK 40	32	72	181	200
HEI.S40.0240.120-KKB	SK 40	40	80	101	120

SK END MILL HOLDER DIN 6359 FOR WELDON DIN 1835-B WITH COOLANT KKB



DIN ISO 7388-1 AD (DIN 69871) SK

FRÄSERAUFNAHME DIN 6359 ZYLINDERSCHÄFTE DIN 1835-B MIT KÜHLMITTEL BOHRUNG

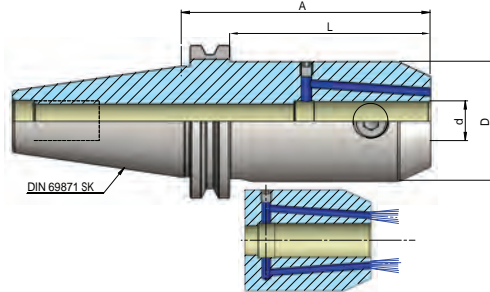
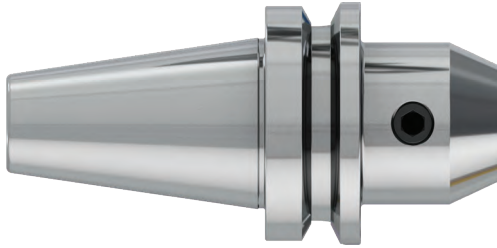

DIN
69871

G 2.5
25.000
MIN

COOLANT

FORM
AD

ISO
7388-1



Artikelbezeichnung Item Code	Kegel Cone	d	D	L	A
HEI.S50.0206.63-KKB	SK 50	6	25	44	63
HEI.S50.0206.100-KKB	SK 50	6	25	81	100
HEI.S50.0206.130-KKB	SK 50	6	25	111	130
HEI.S50.0206.160-KKB	SK 50	6	25	141	160
HEI.S50.0206.200-KKB	SK 50	6	25	181	200
HEI.S50.0208.63-KKB	SK 50	8	28	44	63
HEI.S50.0208.100-KKB	SK 50	8	28	81	100
HEI.S50.0208.130-KKB	SK 50	8	28	111	130
HEI.S50.0208.160-KKB	SK 50	8	28	141	160
HEI.S50.0208.200-KKB	SK 50	8	28	181	200
HEI.S50.0210.63-KKB	SK 50	10	35	44	63
HEI.S50.0210.100-KKB	SK 50	10	35	81	100
HEI.S50.0210.130-KKB	SK 50	10	35	111	130
HEI.S50.0210.160-KKB	SK 50	10	35	141	160
HEI.S50.0210.200-KKB	SK 50	10	35	181	200
HEI.S50.0212.63-KKB	SK 50	12	42	44	63
HEI.S50.0212.100-KKB	SK 50	12	42	81	100
HEI.S50.0212.130-KKB	SK 50	12	42	111	130
HEI.S50.0212.160-KKB	SK 50	12	42	141	160
HEI.S50.0212.200-KKB	SK 50	12	42	181	200
HEI.S50.0214.63-KKB	SK 50	14	45	44	63
HEI.S50.0214.100-KKB	SK 50	14	45	81	100
HEI.S50.0214.130-KKB	SK 50	14	45	111	130
HEI.S50.0214.160-KKB	SK 50	14	45	141	160
HEI.S50.0214.200-KKB	SK 50	14	45	181	200

SK END MILL HOLDER DIN 6359 FOR WELDON DIN 1835-B WITH COOLANT KKB

heikenei.com

DIN ISO 7388-1 AD (DIN 69871) SK

FRÄSERAUFNAHME DIN 6359 ZYLINDERSCHÄFTE DIN 1835-B MIT KÜHLMITTEL BOHRUNG

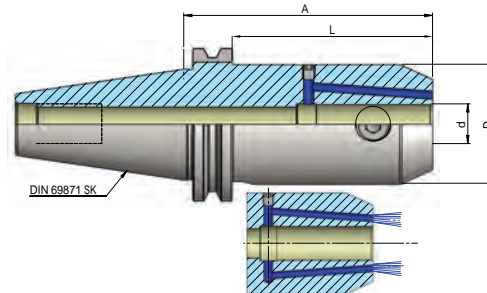

DIN
69871

G 2.5
25.000
MIN

COOLANT

FORM
AD

ISO
7388-1



Artikelbezeichnung Item Code	Kegel Cone	d	D	L	A
HEI.S50.0216.63-KKB	SK 50	16	48	44	63
HEI.S50.0216.100-KKB	SK 50	16	48	81	100
HEI.S50.0216.130-KKB	SK 50	16	48	111	130
HEI.S50.0216.160-KKB	SK 50	16	48	141	160
HEI.S50.0216.200-KKB	SK 50	16	48	181	200
HEI.S50.0218.63-KKB	SK 50	18	50	44	63
HEI.S50.0218.100-KKB	SK 50	18	50	81	100
HEI.S50.0218.130-KKB	SK 50	18	50	111	130
HEI.S50.0218.160-KKB	SK 50	18	50	141	160
HEI.S50.0218.200-KKB	SK 50	18	50	181	200
HEI.S50.0220.63-KKB	SK 50	20	52	44	63
HEI.S50.0220.100-KKB	SK 50	20	52	81	100
HEI.S50.0220.130-KKB	SK 50	20	52	111	130
HEI.S50.0220.160-KKB	SK 50	20	52	141	160
HEI.S50.0220.200-KKB	SK 50	20	52	181	200
HEI.S50.0225.80-KKB	SK 50	25	65	61	80
HEI.S50.0225.130-KKB	SK 50	25	65	111	130
HEI.S50.0225.160-KKB	SK 50	25	65	141	160
HEI.S50.0225.200-KKB	SK 50	25	65	181	200
HEI.S50.0232.100-KKB	SK 50	32	72	81	100
HEI.S50.0232.130-KKB	SK 50	32	72	111	130
HEI.S50.0232.160-KKB	SK 50	32	72	141	160
HEI.S50.0232.200-KKB	SK 50	32	72	181	200
HEI.S50.0240.100-KKB	SK 50	40	80	81	100
HEI.S50.0240.130-KKB	SK 50	40	80	111	130
HEI.S50.0240.160-KKB	SK 50	40	80	141	160
HEI.S50.0240.200-KKB	SK 50	40	80	181	200

SK END MILL HOLDER DIN 6359 FOR WELDON DIN 1835-B WITH COOLANT K

DIN ISO 7388-1 AD (DIN 69871) SK

FRÄSERAUFNAHME DIN 6359 ZYLINDERSCHÄFTE DIN 1835-B MIT KÜHLMITTEL

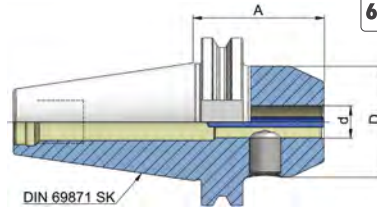
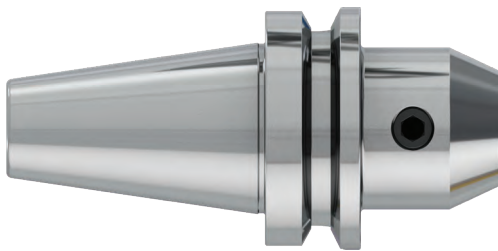

DIN
69871

G 2.5
25.000
MIN

COOLANT

FORM
AD

ISO
7388-1



Artikelbezeichnung Item Code	Produktname Product name	Spannbereich Capacity	D	L	A
HEI.S40.0206.50K	SK 40 6 - 50 - K	6	25	31	50
HEI.S40.0206.100K	SK 40 6 - 100 - K	6	25	81	100
HEI.S40.0208.50K	SK 40 8 - 50 - K	8	28	31	50
HEI.S40.0208.100K	SK 40 8 - 100 - K	8	28	81	100
HEI.S40.0210.50K	SK 40 10 - 50 - K	10	35	31	50
HEI.S40.0210.100K	SK 40 10 - 100 - K	10	35	81	100
HEI.S40.0212.50K	SK 40 12 - 50 - K	12	42	31	50
HEI.S40.0212.100K	SK 40 12 - 100 - K	12	42	81	100
HEI.S40.0214.50K	SK 40 14 - 50 - K	14	45	31	50
HEI.S40.0214.100K	SK 40 14 - 100 - K	14	45	81	100
HEI.S40.0216.63K	SK 40 16 - 63 - K	16	48	44	63
HEI.S40.0216.100K	SK 40 16 - 100 - K	16	48	81	100
HEI.S40.0218.63K	SK 40 18 - 63 - K	18	50	44	63
HEI.S40.0218.100K	SK 40 18 - 100 - K	18	50	81	100
HEI.S40.0218.160K	SK 40 18 - 160 - K	18	50	141	160
HEI.S40.0220.63K	SK 40 20 - 63 - K	20	52	44	63
HEI.S40.0220.100K	SK 40 20 - 100 - K	20	52	81	100
HEI.S40.0225.100K	SK 40 25 - 100 - K	25	63	81	100
HEI.S40.0232.100K	SK 40 32 - 100 - K	32	72	81	100
HEI.S40.0240.120K	SK 40 40 - 120 - K	40	80	101	120

SK END MILL HOLDER DIN 6359

FOR WELDON DIN 1835-B WITH COOLANT K

heikenei.com

DIN ISO 7388-1 AD (DIN 69871) SK

FRÄSERAUFNAHME DIN 6359 ZYLINDERSCHÄFTE DIN 1835-B MIT KÜHLMITTEL

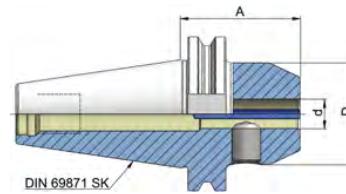
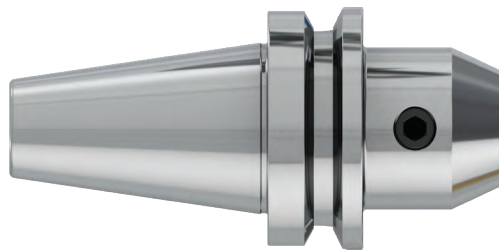

DIN
69871

G 2.5
25.000
MIN

COOLANT

FORM
AD

ISO
7388-1



Artikelbezeichnung Item Code	Produktname Product name	Spannbereich Capacity	D	L	A
HEI.S50.0206.63K	SK 50 6 - 63 - K	6	25	44	63
HEI.S50.0206.100K	SK 50 6 - 100 - K	6	25	81	100
HEI.S50.0208.63K	SK 50 8 - 63 - K	8	28	44	63
HEI.S50.0208.100K	SK 50 8 - 100 - K	8	28	81	100
HEI.S50.0210.63K	SK 50 10 - 63 - K	10	35	44	63
HEI.S50.0210.100K	SK 50 10 - 100 - K	10	35	81	100
HEI.S50.0212.63K	SK 50 12 - 63 - K	12	42	44	63
HEI.S50.0212.100K	SK 50 12 - 100 - K	12	42	81	100
HEI.S50.0214.63K	SK 50 14 - 63 - K	14	45	44	63
HEI.S50.0214.100K	SK 50 14 - 100 - K	14	45	81	100
HEI.S50.0216.63K	SK 50 16 - 63 - K	16	48	44	63
HEI.S50.0216.100K	SK 50 16 - 100 - K	16	48	81	100
HEI.S50.0218.63K	SK 50 18 - 63 - K	18	50	44	63
HEI.S50.0218.100K	SK 50 18 - 100 - K	18	50	81	100
HEI.S50.0220.63K	SK 50 20 - 63 - K	20	52	44	63
HEI.S50.0220.100K	SK 50 20 - 100 - K	20	52	81	100
HEI.S50.0225.80K	SK 50 25 - 80 - K	25	65	61	80
HEI.S50.0225.120K	SK 50 25 - 120 - K	25	65	101	120
HEI.S50.0232.100K	SK 50 32 - 100 - K	32	72	81	100
HEI.S50.0240.100K	SK 50 40 - 100 - K	40	80	81	100

SK SHELL MILL HOLDER DIN 6357 FOR CUTTERS WITH DRIVING SLOT & COOLANT

DIN ISO 7388-1 AD (DIN 69871) SK

QUERNUT-AUFSTECKFRÄSDORN DIN 6357 MIT VERGRÖSSERTEM BUNDDURCHMESSER MIT KÜHLMITTEL

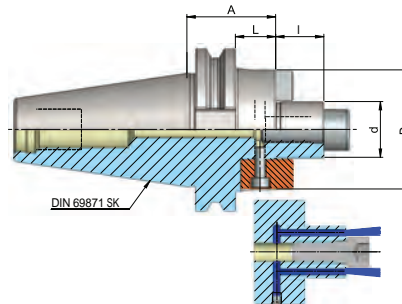

Artikelbezeichnung Item Code	Produktname Product name	Spannbereich Capacity	D	I	L	A
HEI.S30.0316.40	SK 30 16 - 40	16	38	17	21	40
HEI.S30.0322.40	SK 30 22 - 40	22	48	19	21	40
HEI.S30.0327.50	SK 30 27 - 50	27	58	21	31	50
HEI.S30.0332.50	SK 30 32 - 50	32	78	24	31	50
HEI.S40.0316.35	SK 40 16 - 35	16	38	17	16	35
HEI.S40.0316.100	SK 40 16 - 100	16	38	17	81	100
HEI.S40.0316.130	SK 40 16 - 130	16	38	17	111	130
HEI.S40.0316.160	SK 40 16 - 160	16	38	17	141	160
HEI.S40.0322.35	SK 40 22 - 35	22	48	19	16	35
HEI.S40.0322.100	SK 40 22 - 100	22	48	19	81	100
HEI.S40.0322.130	SK 40 22 - 130	22	48	19	111	130
HEI.S40.0322.160	SK 40 22 - 160	22	48	19	141	160
HEI.S40.0327.40	SK 40 27 - 40	27	58	21	21	40
HEI.S40.0327.100	SK 40 27 - 100	27	58	21	81	100
HEI.S40.0327.130	SK 40 27 - 130	27	58	21	111	130
HEI.S40.0327.160	SK 40 27 - 160	27	58	21	141	160
HEI.S40.0332.50	SK 40 32 - 50	32	78	24	31	50
HEI.S40.0332.100	SK 40 32 - 100	32	78	24	81	100
HEI.S40.0332.130	SK 40 32 - 130	32	78	24	111	130
HEI.S40.0332.160	SK 40 32 - 160	32	78	24	141	160
HEI.S40.0340.50	SK 40 40 - 50	40	88		31	50
HEI.S40.0340.100	SK 40 40 - 100	40	88		81	100
HEI.S40.0340.130	SK 40 40 - 130	40	88		111	130
HEI.S40.0340.160	SK 40 40 - 160	40	88		141	160

SK SHELL MILL HOLDER DIN 6357

heikenei.com

FOR CUTTERS WITH DRIVING SLOT & COOLANT

DIN ISO 7388-1 AD (DIN 69871) SK

QUERNUT-AUFSTECKFRÄSDORN DIN 6357 MIT VERGRÖSSERTEM
BUNDDURCHMESSER MIT KÜHLMITTEL

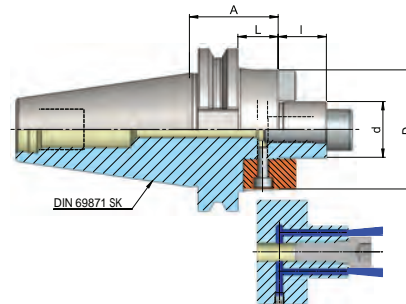

DIN
69871

G 2.5
25.000
MIN

COOLANT

FORM
AD

ISO
7388-1



Artikelbezeichnung Item Code	Produktname Product name	Spannbereich Capacity	D	I	L	A
HEI.S50.0316.35	SK 50 16 - 35	16	38	17	16	35
HEI.S50.0316.100	SK 50 16 - 100	16	38	17	81	100
HEI.S50.0316.130	SK 50 16 - 130	16	38	17	111	130
HEI.S50.0316.160	SK 50 16 - 160	16	38	17	141	160
HEI.S50.0316.200	SK 50 16 - 200	16	38	17	181	200
HEI.S50.0322.35	SK 50 22 - 35	22	48	19	16	35
HEI.S50.0322.100	SK 50 22 - 100	22	48	19	81	100
HEI.S50.0322.130	SK 50 22 - 130	22	48	19	111	130
HEI.S50.0322.160	SK 50 22 - 160	22	48	19	141	160
HEI.S50.0322.200	SK 50 22 - 200	22	48	19	181	200
HEI.S50.0327.40	SK 50 27 - 40	27	58	21	21	40
HEI.S50.0327.100	SK 50 27 - 100	27	58	21	81	100
HEI.S50.0327.130	SK 50 27 - 130	27	58	21	111	130
HEI.S50.0327.160	SK 50 27 - 160	27	58	21	141	160
HEI.S50.0327.200	SK 50 27 - 200	27	58	21	181	200
HEI.S50.0332.50	SK 50 32 - 50	32	78	24	31	50
HEI.S50.0332.100	SK 50 32 - 100	32	78	24	81	100
HEI.S50.0332.130	SK 50 32 - 130	32	78	24	111	130
HEI.S50.0332.160	SK 50 32 - 160	32	78	24	141	160
HEI.S50.0332.200	SK 50 32 - 200	32	78	24	181	200
HEI.S50.0340.50	SK 50 40 - 50	40	88	27	31	50
HEI.S50.0340.100	SK 50 40 - 100	40	88	27	81	100
HEI.S50.0340.130	SK 50 40 - 130	40	88	27	111	130
HEI.S50.0340.160	SK 50 40 - 160	40	88	27	141	160
HEI.S50.0340.200	SK 50 40 - 200	40	88	27	181	200
HEI.S50.0350.70	SK 50 60 - 70	50	128	40	51	70
HEI.S50.0360.70	SK 50 60 - 70	60	128	40	51	70

SK COMBI SHELL MILL HOLDER DIN 6358

DIN ISO 7388-1 AD (DIN 69871) SK

KOMBI-AUFSTECKFRÄSDORN DIN 6358 KÜHLMITTEL

HEIKENEI
wir produzieren industrielle Lösungen

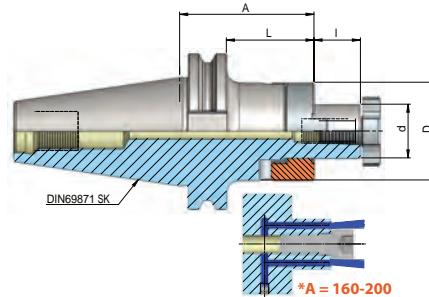

DIN
69871

G 2.5
25.000
MIN

FORM
AD

ISO
7388-1



Artikelbezeichnung Produktname	Item Code Product name	Spannbereich Capacity	D	L	A
HEI.S30.0416.50	SK 30 16 - 50	16	32	31	50
HEI.S30.0422.50	SK 30 22 - 50	22	40	31	50
HEI.S30.0427.55	SK 30 27 - 55	27	48	36	55
HEI.S30.0432.60	SK 30 32 - 60	32	58	41	60
HEI.S40.0416.55	SK 40 16 - 55	16	32	36	55
HEI.S40.0416.100	SK 40 16 - 100	16	32	81	100
HEI.S40.0416.130	SK 40 16 - 130	16	32	111	130
HEI.S40.0416.160	SK 40 16 - 160	16	32	141	160
HEI.S40.0422.55	SK 40 22 - 55	22	40	36	55
HEI.S40.0422.100	SK 40 22 - 100	22	40	81	100
HEI.S40.0422.130	SK 40 22 - 130	22	40	111	130
HEI.S40.0422.160	SK 40 22 - 160	22	40	141	160
HEI.S40.0427.55	SK 40 27 - 55	27	48	36	55
HEI.S40.0427.100	SK 40 27 - 100	27	48	81	100
HEI.S40.0427.130	SK 40 27 - 130	27	48	111	130
HEI.S40.0427.160	SK 40 27 - 160	27	48	141	160
HEI.S40.0432.60	SK 40 32 - 60	32	58	41	60
HEI.S40.0432.100	SK 40 32 - 100	32	58	81	100
HEI.S40.0432.130	SK 40 32 - 130	32	58	111	130
HEI.S40.0432.160	SK 40 32 - 160	32	58	141	160
HEI.S40.0440.60	SK 40 40 - 60	40	70	41	60
HEI.S40.0440.100	SK 40 40 - 100	40	70	81	100

SK COMBI SHELL MILL HOLDER DIN 6358

heikenei.com

DIN ISO 7388-1 AD (DIN 69871) SK

KOMBI-AUFSTECKFRÄSDORN DIN 6358 KÜHLMITTEL

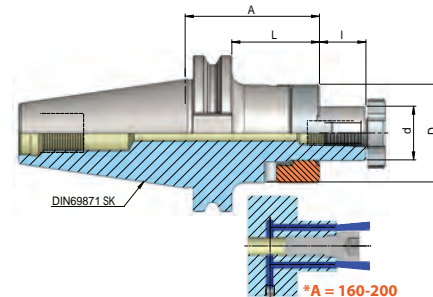

Artikelbezeichnung Item Code	Produktname Product name	Spannbereich Capacity	D	L	A
HEI.S50.0416.55	SK 50 16 - 55	16	32	36	55
HEI.S50.0416.100	SK 50 16 - 100	16	32	81	100
HEI.S50.0416.130	SK 50 16 - 130	16	32	111	130
HEI.S50.0416.160	SK 50 16 - 160	16	32	141	160
HEI.S50.0416.200	SK 50 16 - 200	16	32	181	200
HEI.S50.0422.55	SK 50 22 - 55	22	40	36	55
HEI.S50.0422.100	SK 50 22 - 100	22	40	81	100
HEI.S50.0422.130	SK 50 22 - 130	22	40	111	130
HEI.S50.0422.160	SK 50 22 - 160	22	40	141	160
HEI.S50.0422.200	SK 50 22 - 200	22	40	181	200
HEI.S50.0427.55	SK 50 27 - 55	27	48	36	55
HEI.S50.0427.100	SK 50 27 - 100	27	48	81	100
HEI.S50.0427.130	SK 50 27 - 130	27	48	111	130
HEI.S50.0427.160	SK 50 27 - 160	27	48	141	160
HEI.S50.0427.200	SK 50 27 - 200	27	48	181	200
HEI.S50.0432.55	SK 50 32 - 55	32	58	36	55
HEI.S50.0432.100	SK 50 32 - 100	32	58	81	100
HEI.S50.0432.130	SK 50 32 - 130	32	58	111	130
HEI.S50.0432.160	SK 50 32 - 160	32	58	141	160
HEI.S50.0432.200	SK 50 32 - 200	32	58	181	200
HEI.S50.0440.55	SK 50 40 - 55	40	70	36	55
HEI.S50.0440.100	SK 50 40 - 100	40	70	81	100
HEI.S50.0440.130	SK 50 40 - 130	40	70	111	130
HEI.S50.0440.160	SK 50 40 - 160	40	70	141	160
HEI.S50.0440.200	SK 50 40 - 200	40	70	181	200

SK MORSE TAPER ADAPTOR DIN 6383

DIN ISO 7388-1 AD (DIN 69871) SK

ZWISCHENHÜLSE FÜR MK MIT ANZUGSGEWINDE DIN 6364

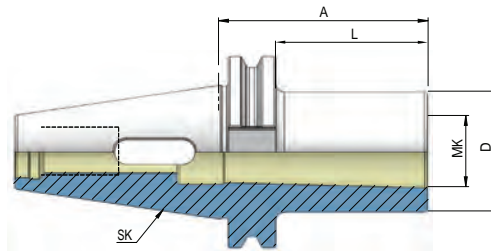
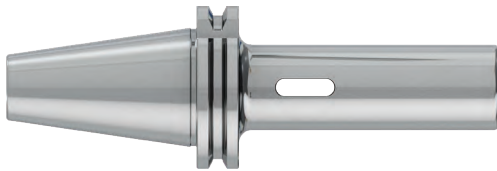

Artikelbezeichnung Item Code	Produktname Product name	MK	D	L	A
HEI.S30.0501.50	SK 30 1 - 50	1	25	31	50
HEI.S30.0502.65	SK 30 2 - 65	2	32	46	65
HEI.S30.0503.80	SK 30 3 - 80	3	40	61	80
HEI.S40.0501.50	SK 40 1 - 50	1	25	31	50
HEI.S40.0502.50	SK 40 2 - 50	2	32	31	50
HEI.S40.0502.117	SK 40 2 - 117	2	32	98	117
HEI.S40.0503.70	SK 40 3 - 70	3	40	51	70
HEI.S40.0503.133	SK 40 3 - 133	3	40	114	133
HEI.S40.0504.95	SK 40 4 - 95	4	48	76	95
HEI.S40.0504.156	SK 40 4 - 156	4	48	137	156
HEI.S50.0501.45	SK 50 1 - 45	1	25	26	45
HEI.S50.0502.60	SK 50 2 - 60	2	32	41	60
HEI.S50.0502.117	SK 50 2 - 117	2	32	98	117
HEI.S50.0503.65	SK 50 3 - 65	3	40	46	65
HEI.S50.0503.137	SK 50 3 - 137	3	40	118	137
HEI.S50.0504.95	SK 50 4 - 95	4	48	76	95
HEI.S50.0504.167	SK 50 4 - 167	4	48	148	167
HEI.S50.0505.105	SK 50 5 - 105	5	63	86	105
HEI.S50.0505.197	SK 50 5 - 197	5	63	178	197

SK MORSE TAPER ADAPTOR WITH THREAD DIN 6364

heikenei.com

DIN ISO 7388-1 A (DIN 69871) SK

ZWISCHENHÜLSE FÜR MK MIT ANZUGSGEWINDE DIN 6364

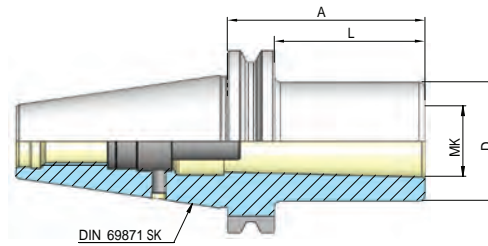
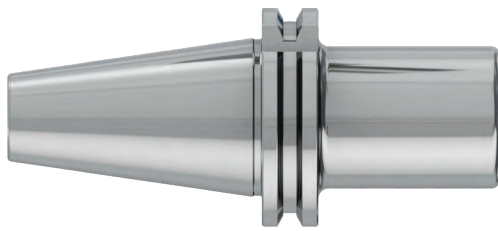

Artikelbezeichnung Item Code	Produktname Product name	MK	D	L	A
HEI.S40.0601.50	SK 40 1 - 50	1	25	31	50
HEI.S40.0602.50	SK 40 2 - 50	2	32	31	50
HEI.S40.0603.70	SK 40 3 - 70	3	40	51	70
HEI.S40.0604.95	SK 40 4 - 95	4	48	76	95
HEI.S50.0601.45	SK 50 1 - 45	1	25	26	45
HEI.S50.0602.60	SK 50 2 - 60	2	32	41	60
HEI.S50.0603.65	SK 50 3 - 65	3	40	46	65
HEI.S50.0604.70	SK 50 4 - 70	4	48	51	70
HEI.S50.0605.100	SK 50 5 - 100	5	63	81	100

SK REDUCING ADAPTER

DIN ISO 7388-1 A (DIN 69871) SK
ZWISCHENHÜLSE/REDUZIERHÜLSE

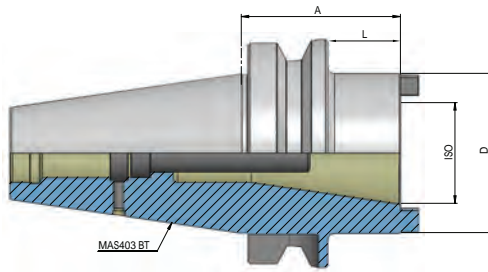

Artikelbezeichnung Item Code	Produktname Product name	ADAPT	D	L	A
HEI.S40.0730.50	SK 40 30 - 50	SK30 - BT30	50	31	50
HEI.S40.0740.100	SK 40 40 - 100	SK40 - BT40	63	81	100
HEI.S50.0740.70	SK 50 40 - 70	SK40 - BT40	70	51	70
HEI.S50.0750.120	SK 50 50 - 120	SK50 - BT50	97	101	120

SK INDEXABLE MILLING ARBORS FOR SCREW TYPE

heikenei.com

DIN ISO 7388-1 AD (DIN 69871) SK
FRÄSAUFNAHME FÜR EINSCHRAUBFRÄSER

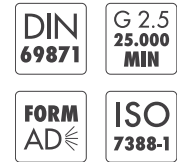
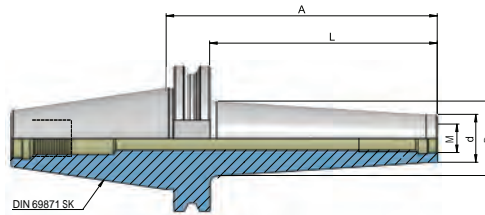
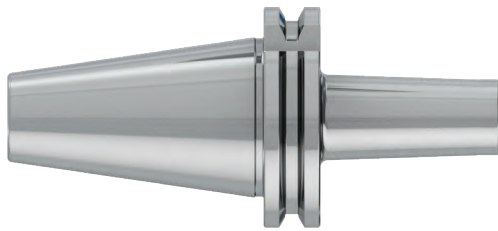

Artikelbezeichnung Item Code	Produktname Product name	Spannbereich Capacity	d	D	L	A
HEI.S40.0806.44	SK 40 M6 - 44	M6	10	13	25	44
HEI.S40.0806.69	SK 40 M6 - 69	M6	10	20	50	69
HEI.S40.0806.94	SK 40 M6 - 94	M6	10	23	75	94
HEI.S40.0808.44	SK 40 M8 - 44	M8	13	15	25	44
HEI.S40.0808.69	SK 40 M8 - 69	M8	13	23	50	69
HEI.S40.0808.94	SK 40 M8 - 94	M8	13	23	75	94
HEI.S40.0808.119	SK 40 M8 - 119	M8	13	25	100	119
HEI.S40.0810.24	SK 40 M10 - 24	M10	18	18	5	24
HEI.S40.0810.44	SK 40 M10 - 44	M10	18	20	25	44
HEI.S40.0810.69	SK 40 M10 - 69	M10	18	23	50	69
HEI.S40.0810.94	SK 40 M10 - 94	M10	18	28	75	94
HEI.S40.0810.119	SK 40 M10 - 119	M10	18	32	100	119
HEI.S40.0810.169	SK 40 M10 - 169	M10	18	36	150	169
HEI.S40.0812.24	SK 40 M12 - 24	M12	21	21	5	24
HEI.S40.0812.44	SK40 M12 - 44	M12	21	24	25	44
HEI.S40.0812.69	SK 40 M12 - 69	M12	21	27	50	69
HEI.S40.0812.94	SK 40 M12 - 94	M12	21	30	75	94
HEI.S40.0812.119	SK 40 M12 - 119	M12	21	33	100	119
HEI.S40.0812.144	SK 40 M12 - 144	M12	21	36	125	144
HEI.S40.0812.169	SK 40 M12 - 169	M12	21	40	150	169
HEI.S40.0816.24	SK 40 M16 - 24	M16	29	29	5	24
HEI.S40.0816.44	SK 40 M16 - 44	M16	29	29	25	44
HEI.S40.0816.69	SK 40 M16 - 69	M16	29	32	50	69
HEI.S40.0816.94	SK 40 M16 - 94	M16	29	34	75	94
HEI.S40.0816.119	SK 40 M16 - 119	M16	29	36	100	119
HEI.S40.0816.144	SK 40 M16 - 144	M16	29	40	125	144
HEI.S40.0816.169	SK 40 M16 - 169	M16	29	42	150	169

SK INDEXABLE MILLING ARBORS FOR SCREW TYPE

DIN ISO 7388-1 AD (DIN 69871) SK
FRÄSAUFNAHME FÜR EINSCHRAUBFRÄSER

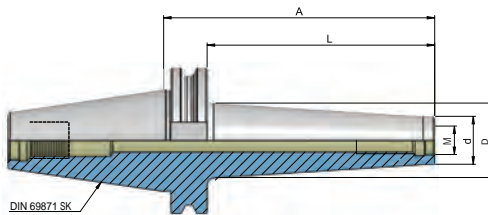
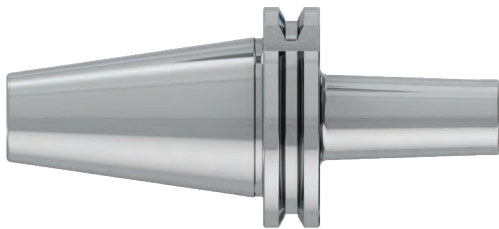

Artikelbezeichnung Item Code	Produktname Product name	Spannbereich Capacity	d	D	L	A
HEI.S50.0806.69	SK 50 M6 - 69	M6	13	23	50	69
HEI.S50.0806.119	SK 50 M6 - 119	M6	13	25	100	119
HEI.S50.0806.169	SK 50 M6 - 169	M6	13	30	150	169
HEI.S50.0808.69	SK 50 M8 - 69	M8	13	23	50	69
HEI.S50.0808.119	SK 50 M8 - 119	M8	13	25	100	119
HEI.S50.0808.169	SK 50 M8 - 169	M8	13	30	150	169
HEI.S50.0810.69	SK 50 M10 - 69	M10	18	23	50	69
HEI.S50.0810.119	SK 50 M10 - 119	M10	18	32	100	119
HEI.S50.0810.169	SK 50 M10 - 169	M10	18	36	150	169
HEI.S50.0812.69	SK 50 M12 - 69	M12	21	24	50	69
HEI.S50.0812.119	SK 50 M12 - 119	M12	21	33	100	119
HEI.S50.0812.169	SK 50 M12 - 169	M12	21	40	150	169
HEI.S50.0816.69	SK 50 M16 - 69	M16	29	34	50	69
HEI.S50.0816.119	SK 50 M16 - 119	M16	29	36	100	119
HEI.S50.0816.169	SK 50 M16 - 169	M16	29	42	150	169

SK HOLDER FOR INDEXABLE DRILLS E1

heikenei.com

DIN ISO 7388-1 AD (DIN 69871) SK

BOHRERHALTER FÜR WENDEPLATTENBOHRER E1

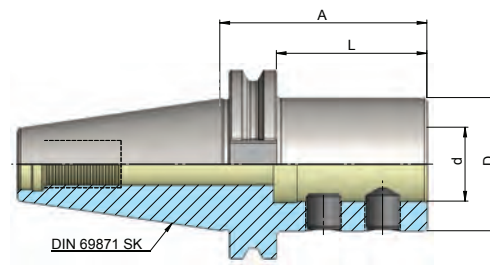

Artikelbezeichnung Item Code	Produktname Product name	Spannbereich Capacity	D	L	A
HEI.S40.1420.65	SK 40 20 - 65 - E1	20	40	46	65
HEI.S40.1425.70	SK 40 25 - 70 - E1	25	45	51	70
HEI.S40.1432.75	SK 40 32 - 75 - E1	32	52	56	75
HEI.S50.1420.70	SK 50 20 - 70 - E1	20	40	51	70
HEI.S50.1425.70	SK 50 25 - 70 - E1	25	45	51	70
HEI.S50.1432.70	SK 50 32 - 70 - E1	32	52	51	70
HEI.S50.1440.80	SK 50 40 - 80 - E1	40	60	61	80

SK BLANK BAR

DIN ISO 7388-1 A (DIN 69871) SK

BOHRSTANGENROHLING ZUR ANFERTIGUNG VON SONDERWERKZEUGEN

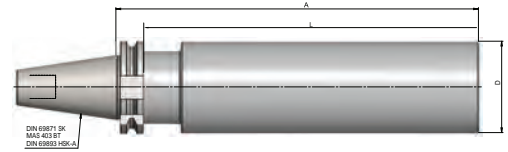

Artikelbezeichnung Item Code	Produktname Product name	D	L	A
HEI.S40.1063.250	SK 40 63 - 250	63	234	250
HEI.S50.1097.315	SK 50 97- 315	97	299	315

HSK

heikenei.com

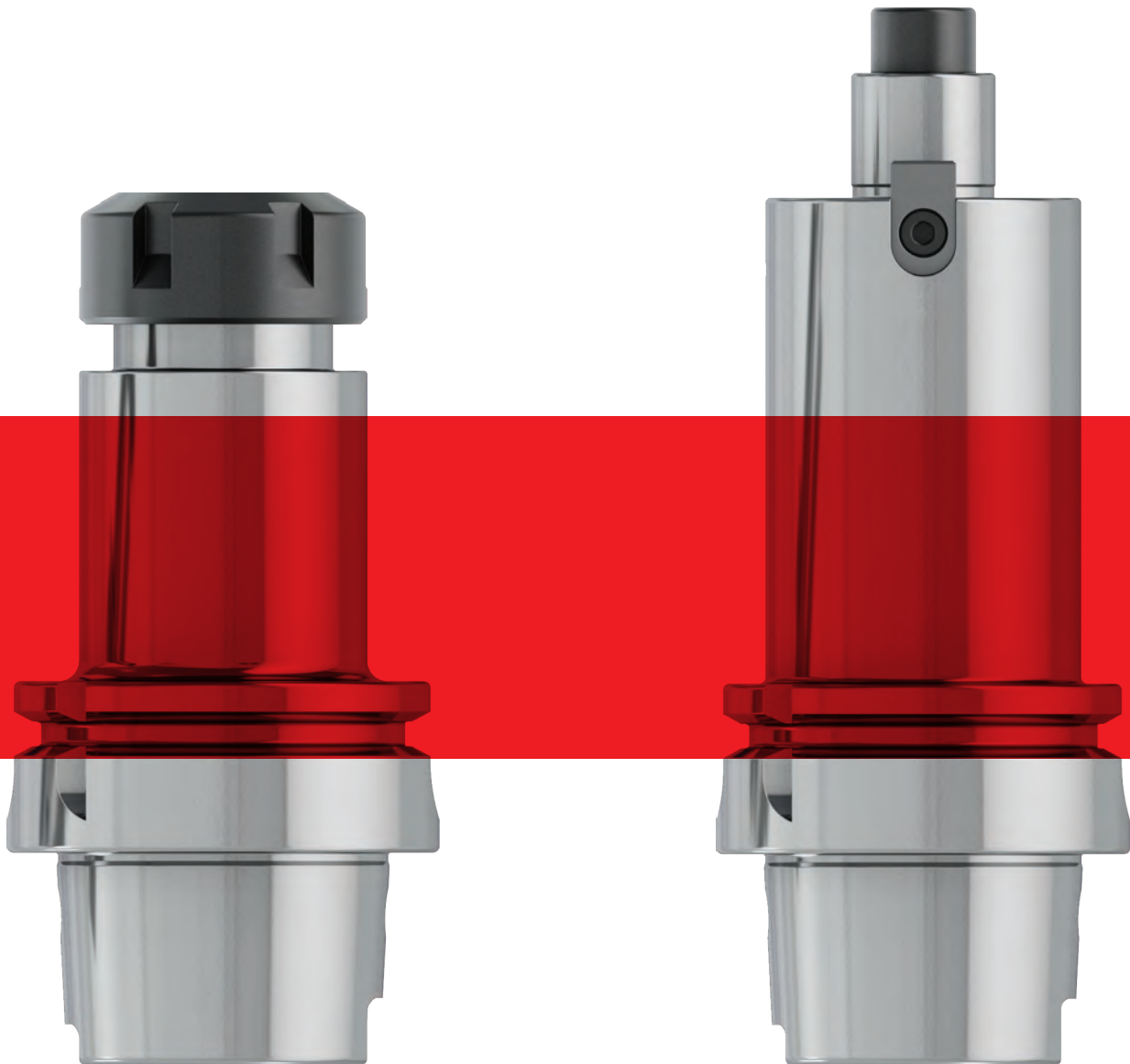

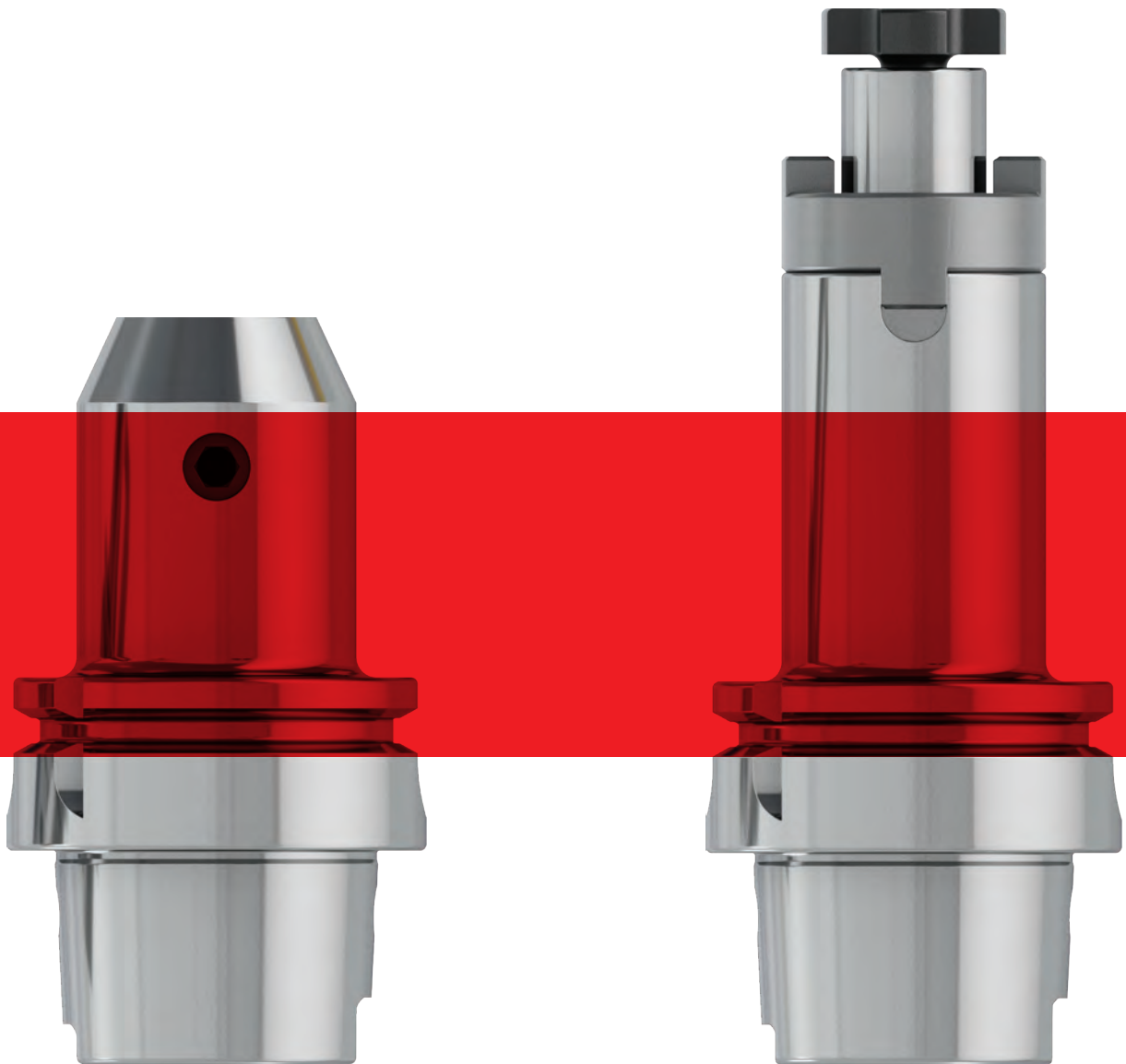

PG. 58 - 78

HSK-A HOLDING SYSTEM DIMENSIONS

heikenei.com

ISO 12164-1 (DIN 69893-1) HSK FORM A

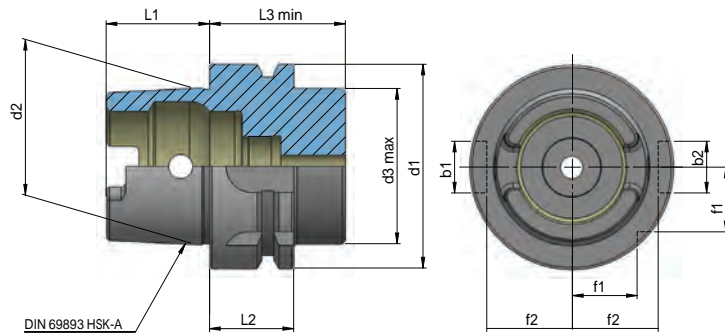

Dimensions	Ø d1	Ø d2	Ø d3	L1	L2	L3	b1	b2	f1	f2
HSK 50	50	38	42	25	26	42	14	12	15,5	21
HSK63	63	48	53	32	26	42	18	20	20	26,5
HSK100	100	75	85	50	29	45	20	22	31,5	44

HSK-A COLLET CHUCKS FOR COLLECTS DIN 6499 ER

ISO 12164-1 (DIN 69893-1) HSK FORM A
SPANNZANGENFUTTER DIN 6499 ER

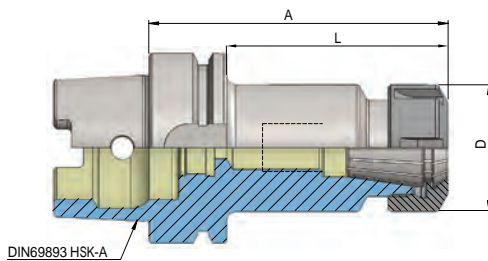

Artikelbezeichnung Item Code	Produktname Product name	Spannbereich Capacity	D	L	A
HEI.A50.0116.100	HSK 50 ER 16 - 100	1 - 10	28	74	100
HEI.A50.0125.100	HSK 50 ER 25 - 100	2 - 16	42	74	100
HEI.A50.0132.100	HSK 50 ER 32 - 100	2 - 20	50	74	100
HEI.A63.0116.100	HSK 63 ER 16 - 100	1 - 10	28	74	100
HEI.A63.0116.130	HSK 63 ER 16 - 130	1 - 10	28	104	130
HEI.A63.0116.160	HSK 63 ER 16 - 160	1 - 10	28	134	160
HEI.A63.0125.100	HSK 63 ER 25 - 100	2 - 16	42	74	100
HEI.A63.0125.130	HSK 63 ER 25 - 130	2 - 16	42	104	130
HEI.A63.0125.160	HSK 63 ER 25 - 160	2 - 16	42	134	160
HEI.A63.0132.100	HSK 63 ER 32 - 100	2 - 20	50	74	100
HEI.A63.0132.130	HSK 63 ER 32 - 130	2 - 20	50	104	130
HEI.A63.0132.160	HSK 63 ER 32 - 160	2 - 20	50	134	160
HEI.A63.0140.120	HSK 63 ER 40 - 120	3 - 26	63	94	120
HEI.A63.0140.160	HSK 63 ER 40 - 160	3 - 26	63	134	160
HEI.A100.0116.100	HSK 100 ER 16 - 100	1 - 10	28	71	100
HEI.A100.0116.130	HSK 100 ER 16 - 130	1 - 10	28	101	130
HEI.A100.0116.160	HSK 100 ER 16 - 160	1 - 10	28	131	160
HEI.A100.0116.200	HSK 100 ER 16 - 200	1 - 10	28	171	200
HEI.A100.0125.100	HSK 100 ER 25 - 100	2 - 16	42	71	100
HEI.A100.0125.130	HSK 100 ER 25 - 130	2 - 16	42	101	130
HEI.A100.0125.160	HSK 100 ER 25 - 160	2 - 16	42	131	160
HEI.A100.0125.200	HSK 100 ER 25 - 200	2 - 16	42	171	200
HEI.A100.0132.100	HSK 100 ER 32 - 100	2 - 20	50	71	100
HEI.A100.0132.130	HSK 100 ER 32 - 130	2 - 20	50	101	130
HEI.A100.0132.160	HSK 100 ER 32 - 160	2 - 20	50	131	160
HEI.A100.0132.200	HSK 100 ER 32 - 200	2 - 20	50	171	200
HEI.A100.0140.120	HSK 100 ER40 - 120	3 - 26	63	91	120
HEI.A100.0140.160	HSK 100 ER40 - 160	3 - 26	63	131	160
HEI.A100.0140.200	HSK 100 ER40 - 200	3 - 26	63	171	200

HSK-A COLLET CHUCKS FOR COLLETS DIN 6499 ER MINI

heikenei.com

ISO 12164-1 (DIN 69893-1) HSK FORM A
SPANNZANGENFUTTER DIN 6499 ER MINI

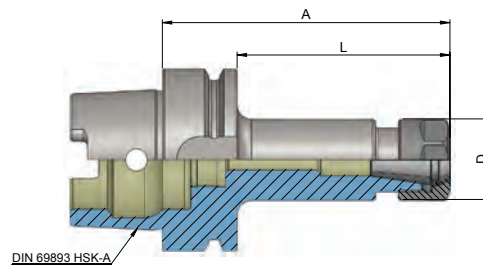

DIN
69893-1

G 2.5
25.000
MIN

FORM
AD

ISO
12164-1



Artikelbezeichnung Item Code	Produktname Product name	Spannbereich Capacity	D	L	A
HEI.A63.0111.100M	HSK 63 ER 11 100 - M	1 - 7	16	74	100
HEI.A63.0111.130M	HSK 63 ER 11 130 - M	1 - 7	16	104	130
HEI.A63.0111.160M	HSK 63 ER 11 160 - M	1 - 7	16	134	160
HEI.A63.0116.100M	HSK 63 ER 16 100 - M	1 - 10	22	74	100
HEI.A63.0116.130M	HSK 63 ER 16 130 - M	1 - 10	22	104	130
HEI.A63.0116.160M	HSK 63 ER 16 160 - M	1 - 10	22	134	160
HEI.A100.0116.100M	HSK 100 ER 16 100 - M	1 - 10	22	71	100
HEI.A100.0116.130M	HSK 100 ER 16 130 - M	1 - 10	22	101	130
HEI.A100.0116.160M	HSK 100 ER 16 160 - M	1 - 10	22	131	160

HSK-A COLLET CHUCKS DIN 6391 FOR COLLETS DIN 6388-OZ

ISO 12164-1 (DIN 69893-1) HSK FORM A

SPANNFUTTER DIN 6391 FÜR SPANNZANGEN DIN 6388-OZ

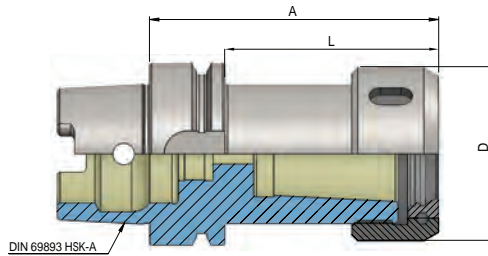

Artikelbezeichnung Item Code	Produktname Product name	Spannbereich Capacity	D	L	A
HEI.A50.0116.100.OZ	HSK 50 E 416 - 100	2 - 16	43	74	100
HEI.A50.0125.100.OZ	HSK 50 E 462 - 100	2 - 25	60	74	100
HEI.A63.0116.100.OZ	HSK 63 E 416 - 100	2 - 16	43	74	100
HEI.A63.0125.100.OZ	HSK 63 E 462 - 100	2 - 25	60	74	100
HEI.A63.0132.120.OZ	HSK 63 E 467 - 120	3 - 32	72	94	120
HEI.A100.0116.110.OZ	HSK 100 E 416 - 110	2 - 16	43	81	110
HEI.A100.0125.120.OZ	HSK 100 E 462 - 120	2 - 25	60	91	120
HEI.A100.0132.130.OZ	HSK 100 E 467 - 130	3 - 32	72	101	130

HSK-A END MILL HOLDER DIN 6359 FOR WELDON DIN 1835-B

heikenei.com

ISO 12164-1 (DIN 69893-1) HSK FORM A

FRÄSERAUFNAHME DIN 6359 ZYLINDERSCHÄFTE DIN 1835-B

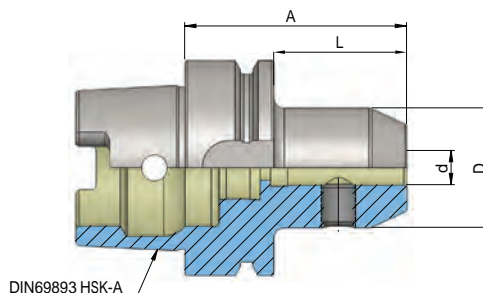
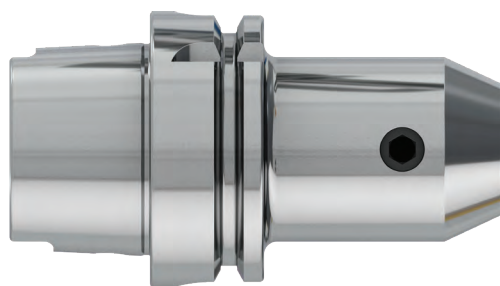

Artikelbezeichnung Item Code	Produktname Product name	Spannbereich Capacity	D	L	A
HEI.A50.0206.65	HSK 50 6 - 65	6	25	39	65
HEI.A50.0208.65	HSK 50 8 - 65	8	28	39	65
HEI.A50.0210.65	HSK 50 10 - 65	10	35	39	65
HEI.A50.0212.80	HSK 50 12 - 80	12	42	54	80
HEI.A50.0214.80	HSK 50 14 - 80	14	44	54	80
HEI.A50.0216.80	HSK 50 16 - 80	16	48	54	80
HEI.A50.0218.80	HSK 50 18 - 80	18	50	54	80
HEI.A50.0220.80	HSK 50 20 - 80	20	52	54	80
HEI.A63.0206.65	HSK 63 6 - 65	6	25	39	65
HEI.A63.0206.100	HSK 63 6 - 100	6	25	74	100
HEI.A63.0206.130	HSK 63 6 - 130	6	25	104	130
HEI.A63.0206.160	HSK 63 6 - 160	6	25	134	160
HEI.A63.0208.65	HSK 63 8 - 65	8	28	39	65
HEI.A63.0208.100	HSK 63 8 - 100	8	28	74	100
HEI.A63.0208.130	HSK 63 8 - 130	8	28	104	130
HEI.A63.0208.160	HSK 63 8 - 160	8	28	134	160
HEI.A63.0210.65	HSK 63 10 - 65	10	35	39	65
HEI.A63.0210.100	HSK 63 10 - 100	10	35	74	100
HEI.A63.0210.130	HSK 63 10 - 130	10	35	104	130
HEI.A63.0210.160	HSK 63 10 - 160	10	35	134	160
HEI.A63.0212.80	HSK 63 12 - 80	12	42	54	80
HEI.A63.0212.100	HSK 63 12 - 100	12	42	74	100
HEI.A63.0212.130	HSK 63 12 - 130	12	42	104	130
HEI.A63.0212.160	HSK 63 12 - 160	12	42	134	160
HEI.A63.0214.80	HSK 63 14 - 80	14	45	54	80
HEI.A63.0214.100	HSK 63 14 - 100	14	45	74	100
HEI.A63.0214.130	HSK 63 14 - 130	14	45	104	130
HEI.A63.0214.160	HSK 63 14 - 160	14	45	134	160

HSK-A END MILL HOLDER DIN 6359 FOR WELDON DIN 1835-B

ISO 12164-1 (DIN 69893-1) HSK FORM A

FRÄSERAUFNAHME DIN 6359 ZYLINDERSCHÄFTE DIN 1835-B

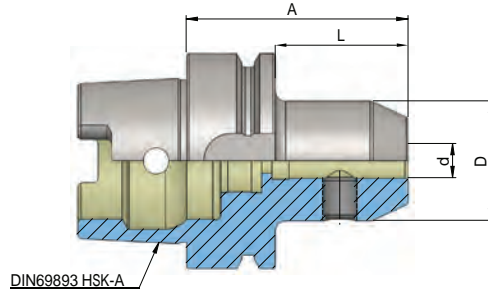
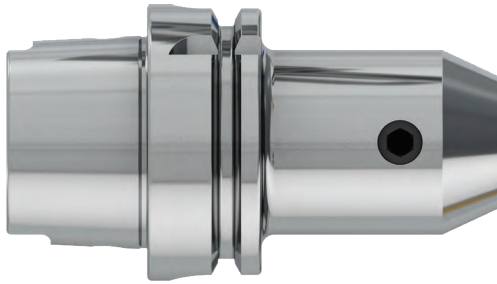

Artikelbezeichnung Item Code	Produktname Product name	Spannbereich Capacity	D	L	A
HEI.A63.0216.80	HSK 63 16 - 80	16	48	54	80
HEI.A63.0216.100	HSK 63 16 - 100	16	48	74	100
HEI.A63.0216.130	HSK 63 16 - 130	16	48	104	130
HEI.A63.0216.160	HSK 63 16 - 160	16	48	134	160
HEI.A63.0218.80	HSK 63 18 - 80	18	50	54	80
HEI.A63.0218.100	HSK 63 18 - 100	18	50	74	100
HEI.A63.0218.130	HSK 63 18 - 130	18	50	104	130
HEI.A63.0218.160	HSK 63 18 - 160	18	50	134	160
HEI.A63.0220.80	HSK 63 20 - 80	20	52	54	80
HEI.A63.0220.100	HSK 63 20 - 100	20	52	74	100
HEI.A63.0220.130	HSK 63 20 - 130	20	52	104	130
HEI.A63.0220.160	HSK 63 20 - 160	20	52	134	160
HEI.A63.0225.110	HSK 63 25 - 110	25	63	84	110
HEI.A63.0225.160	HSK 63 25 - 160	25	63	134	160
HEI.A63.0232.110	HSK 63 32 - 110	32	72	84	110
HEI.A63.0232.160	HSK 63 32 - 160	32	72	134	160
HEI.A63.0240.125	HSK 63 40 - 125	40	80	99	125
HEI.A100.0206.80	HSK 100 6 - 80	6	25	51	80
HEI.A100.0206.100	HSK 100 6 - 100	6	25	71	100
HEI.A100.0206.130	HSK 100 6 - 130	6	25	101	130
HEI.A100.0206.160	HSK 100 6 - 160	6	25	131	160
HEI.A100.0208.80	HSK 100 8 - 80	8	28	51	80
HEI.A100.0208.100	HSK 100 8 - 100	8	28	71	100
HEI.A100.0208.130	HSK 100 8 - 130	8	28	101	130
HEI.A100.0208.160	HSK 100 8 - 160	8	28	131	160

HSK-A END MILL HOLDER DIN 6359 FOR WELDON DIN 1835-B

heikenei.com

ISO 12164-1 (DIN 69893-1) HSK FORM A

FRÄSERAUFNAHME DIN 6359 ZYLINDERSCHÄFTE DIN 1835-B

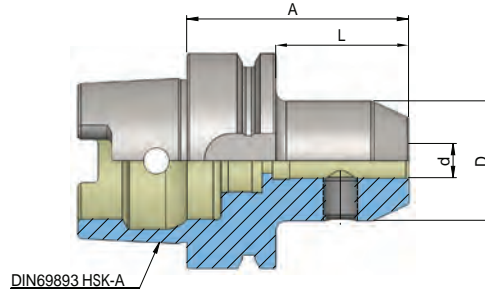
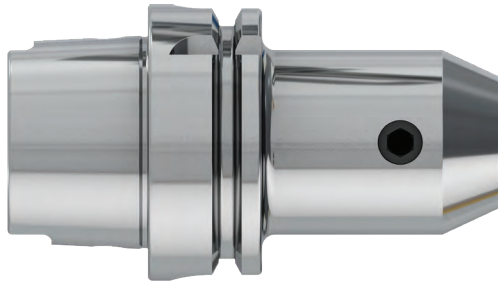

Artikelbezeichnung Item Code	Produktname Product name	Spannbereich Capacity	D	L	A
HEI.A100.0210.80	HSK 100 10 - 80	10	35	51	80
HEI.A100.0210.100	HSK 100 10 - 100	10	35	71	100
HEI.A100.0210.130	HSK 100 10 - 130	10	35	101	130
HEI.A100.0210.160	HSK 100 10 - 160	10	35	131	160
HEI.A100.0212.80	HSK 100 12 - 80	12	42	51	80
HEI.A100.0212.100	HSK 100 12 - 100	12	42	71	100
HEI.A100.0212.130	HSK 100 12 - 130	12	42	101	130
HEI.A100.0212.160	HSK 100 12 - 160	12	42	131	160
HEI.A100.0214.80	HSK 100 14 - 80	14	45	51	80
HEI.A100.0214.130	HSK 100 14 - 130	14	45	101	130
HEI.A100.0214.160	HSK 100 14 - 160	14	45	131	160
HEI.A100.0216.100	HSK 100 16 - 100	16	48	71	100
HEI.A100.0216.130	HSK 100 16 - 130	16	48	101	130
HEI.A100.0216.160	HSK 100 16 - 160	16	48	131	160
HEI.A100.0218.100	HSK 100 18 - 100	18	50	71	100
HEI.A100.0218.130	HSK 100 18 - 130	18	50	101	130
HEI.A100.0218.160	HSK 100 18 - 160	18	50	131	160
HEI.A100.0220.100	HSK 100 20 - 100	20	52	71	100
HEI.A100.0220.130	HSK 100 20 - 130	20	52	101	130
HEI.A100.0220.160	HSK 100 20 - 160	20	52	131	160
HEI.A100.0225.100	HSK 100 25 - 100	25	65	71	100
HEI.A100.0225.130	HSK 100 25 - 130	25	65	101	130
HEI.A100.0225.160	HSK 100 25 - 160	25	65	131	160
HEI.A100.0232.100	HSK 100 32 - 100	32	72	71	100
HEI.A100.0232.130	HSK 100 32 - 130	32	72	101	130
HEI.A100.0232.160	HSK 100 32 - 160	32	72	131	160
HEI.A100.0240.105	HSK 100 40 - 105	40	80	76	105
HEI.A100.0240.160	HSK 100 40 - 160	40	80	131	160

HSK-A END MILL HOLDER DIN 6359 FOR WELDON DIN 1835-B WITH COOLANT

ISO 12164-1 (DIN 69893-1) HSK FORM A

FRÄSERAUFNAHME DIN 6359 ZYLINDERSCHÄFTE DIN 1835-B MIT KÜHLMITTEL

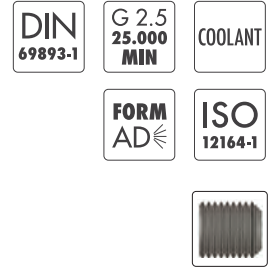
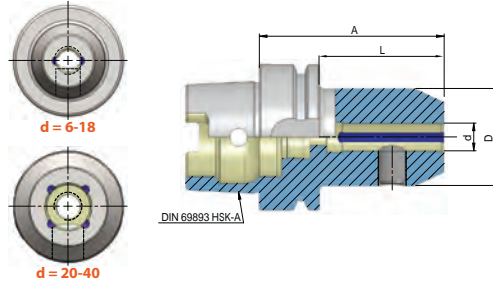
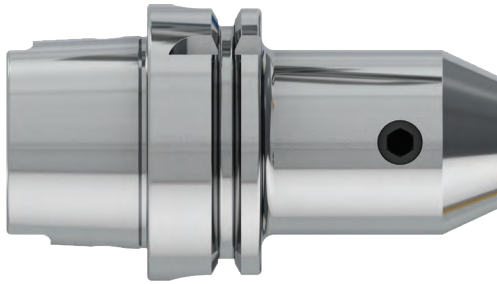

Artikelbezeichnung Item Code	Produktname Product name	Spannbereich Capacity	D	L	A
HEI.A50.0206.65K	HSK 50 6 - 65 - K	6	25	39	65
HEI.A50.0208.65K	HSK 50 8 - 65 - K	8	28	39	65
HEI.A50.0210.65K	HSK 50 10 - 65 - K	10	35	39	65
HEI.A50.0212.80K	HSK 50 12 - 80 - K	12	42	54	80
HEI.A50.0214.80K	HSK 50 14 - 80 - K	14	45	54	80
HEI.A50.0216.80K	HSK 50 16 - 80 - K	16	48	54	80
HEI.A50.0218.80K	HSK 50 18 - 80 - K	18	50	54	80
HEI.A50.0220.80K	HSK 50 20 - 80 - K	20	52	54	80
HEI.A63.0206.65K	HSK 63 6 - 65 - K	6	25	39	65
HEI.A63.0208.65K	HSK 63 8 - 65 - K	8	28	39	65
HEI.A63.0210.65K	HSK 63 10 - 65 - K	10	35	39	65
HEI.A63.0212.80K	HSK 63 12 - 80 - K	12	42	54	80
HEI.A63.0214.80K	HSK 63 14 - 80 - K	14	45	54	80
HEI.A63.0216.80K	HSK 63 16 - 80 - K	16	48	54	80
HEI.A63.0218.80K	HSK 63 18 - 80 - K	18	50	54	80
HEI.A63.0220.80K	HSK 63 20 - 80 - K	20	52	54	80
HEI.A63.0225.110K	HSK 63 25 - 110 - K	25	63	84	110
HEI.A63.0232.110K	HSK 63 32 - 110 - K	32	72	84	110
HEI.A63.0240.125K	HSK 63 40 - 125 - K	40	80	99	125
HEI.A100.0206.80K	HSK 100 6 - 80 - K	6	25	51	80
HEI.A100.0208.80K	HSK 100 8 - 80 - K	8	28	51	80
HEI.A100.0210.80K	HSK 100 10 - 80 - K	10	35	51	80
HEI.A100.0212.80K	HSK 100 12 - 80 - K	12	42	51	80
HEI.A100.0214.80K	HSK 100 14 - 80 - K	14	45	51	80
HEI.A100.0216.100K	HSK 100 16 - 100 - K	16	48	71	100
HEI.A100.0218.100K	HSK 100 18 - 100 - K	18	50	71	100
HEI.A100.0220.100K	HSK 100 20 - 100 - K	20	52	71	100
HEI.A100.0225.100K	HSK 100 25 - 100 - K	25	63	71	100
HEI.A100.0232.100K	HSK 100 32 - 100 - K	32	72	71	100
HEI.A100.0240.105K	HSK 100 40 - 105 - K	40	80	76	105

HSK-A END MILL HOLDER DIN 6359 FOR WELDON DIN 1835-B WITH COOLANT

heikenei.com

ISO 12164-1 (DIN 69893-1) HSK FORM A

FRÄSERAUFNAHME DIN 6359 ZYLINDERSCHÄFTE DIN 1835-B MIT KÜHLMITTEL BOHRUNG

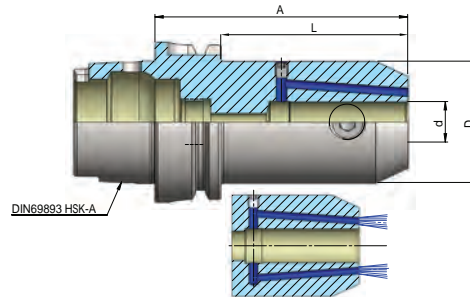

DIN
69893-1

G 2.5
25.000
MIN

COOLANT

FORM
AD

ISO
12164-1



Artikelbezeichnung Item Code	Kegel Cone	d	D	L	A
HEI.A63.0206.65-KKB	HSK 63	6	25	39	65
HEI.A63.0206.100-KKB	HSK 63	6	25	74	100
HEI.A63.0206.130-KKB	HSK 63	6	25	104	130
HEI.A63.0206.160-KKB	HSK 63	6	25	134	160
HEI.A63.0206.200-KKB	HSK 63	6	25	174	200
HEI.A63.0208.65-KKB	HSK 63	8	28	39	65
HEI.A63.0208.100-KKB	HSK 63	8	28	74	100
HEI.A63.0208.130-KKB	HSK 63	8	28	104	130
HEI.A63.0208.160-KKB	HSK 63	8	28	134	160
HEI.A63.0208.200-KKB	HSK 63	8	28	174	200
HEI.A63.0210.65-KKB	HSK 63	10	35	39	65
HEI.A63.0210.100-KKB	HSK 63	10	35	74	100
HEI.A63.0210.130-KKB	HSK 63	10	35	104	130
HEI.A63.0210.160-KKB	HSK 63	10	35	134	160
HEI.A63.0210.200-KKB	HSK 63	10	35	174	200
HEI.A63.0212.80-KKB	HSK 63	12	42	54	80
HEI.A63.0212.100-KKB	HSK 63	12	42	74	100
HEI.A63.0212.130-KKB	HSK 63	12	42	104	130
HEI.A63.0212.160-KKB	HSK 63	12	42	134	160
HEI.A63.0212.200-KKB	HSK 63	12	42	174	200
HEI.A63.0214.80-KKB	HSK 63	14	45	54	80
HEI.A63.0214.100-KKB	HSK 63	14	45	74	100
HEI.A63.0214.130-KKB	HSK 63	14	45	104	130
HEI.A63.0214.160-KKB	HSK 63	14	45	134	160
HEI.A63.0214.200-KKB	HSK 63	14	45	174	200

HSK-A END MILL HOLDER DIN 6359 FOR WELDON DIN 1835-B WITH COOLANT



ISO 12164-1 (DIN 69893-1) HSK FORM A

FRÄSERAUFNAHME DIN 6359 ZYLINDERSCHÄFTE DIN 1835-B MIT KÜHLMITTEL BOHRUNG

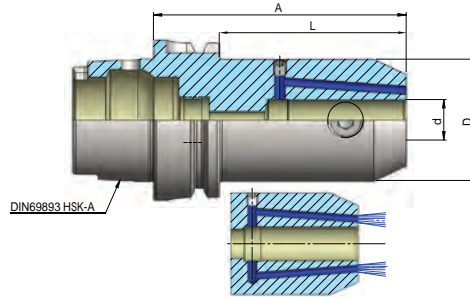
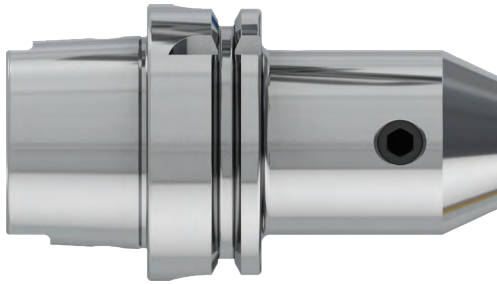

DIN
69893-1

G 2.5
25.000
MIN

COOLANT

FORM
AD

ISO
12164-1



Artikelbezeichnung Item Code	Kegel Cone	d	D	L	A
HEI.A63.0216.80-KKB	HSK 63	16	48	54	80
HEI.A63.0216.100-KKB	HSK 63	16	48	74	100
HEI.A63.0216.130-KKB	HSK 63	16	48	104	130
HEI.A63.0216.160-KKB	HSK 63	16	48	134	160
HEI.A63.0216.200-KKB	HSK 63	16	48	174	200
HEI.A63.0218.80-KKB	HSK 63	18	50	54	80
HEI.A63.0218.100-KKB	HSK 63	18	50	74	100
HEI.A63.0218.130-KKB	HSK 63	18	50	104	130
HEI.A63.0218.160-KKB	HSK 63	18	50	134	160
HEI.A63.0218.200-KKB	HSK 63	18	50	174	200
HEI.A63.0220.80-KKB	HSK 63	20	52	54	80
HEI.A63.0220.100-KKB	HSK 63	20	52	74	100
HEI.A63.0220.130-KKB	HSK 63	20	52	104	130
HEI.A63.0220.160-KKB	HSK 63	20	52	134	160
HEI.A63.0220.200-KKB	HSK 63	20	52	174	200
HEI.A63.0225.110-KKB	HSK 63	25	63	84	110
HEI.A63.0225.160-KKB	HSK 63	25	63	134	160
HEI.A63.0232.110-KKB	HSK 63	32	72	84	110
HEI.A63.0232.160-KKB	HSK 63	32	72	134	160
HEI.A63.0240.125-KKB	HSK 63	40	80	99	125
HEI.A63.0240.160-KKB	HSK 63	40	80	134	160

HSK-A END MILL HOLDER DIN 6359 FOR WELDON DIN 1835-B WITH COOLANT

heikenei.com

ISO 12164-1 (DIN 69893-1) HSK FORM A

FRÄSERAUFNAHME DIN 6359 ZYLINDERSCHÄFTE DIN 1835-B MIT KÜHLMITTEL BOHRUNG

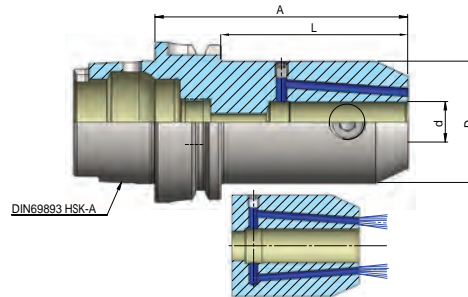

DIN
69893-1

G 2.5
25.000
MIN

COOLANT

FORM
AD

ISO
12164-1



Artikelbezeichnung Item Code	Kegel Cone	d	D	L	A
HEI.A100.0206.80-KKB	HSK 100	6	25	51	80
HEI.A100.0206.100-KKB	HSK 100	6	25	71	100
HEI.A100.0206.130-KKB	HSK 100	6	25	101	130
HEI.A100.0206.160-KKB	HSK 100	6	25	131	160
HEI.A100.0206.200-KKB	HSK 100	6	25	171	200
HEI.A100.0208.80-KKB	HSK 100	8	28	51	80
HEI.A100.0208.100-KKB	HSK 100	8	28	71	100
HEI.A100.0208.130-KKB	HSK 100	8	28	101	130
HEI.A100.0208.160-KKB	HSK 100	8	28	131	160
HEI.A100.0208.200-KKB	HSK 100	8	28	171	200
HEI.A100.0210.80-KKB	HSK 100	10	35	51	80
HEI.A100.0210.100-KKB	HSK 100	10	35	71	100
HEI.A100.0210.130-KKB	HSK 100	10	35	101	130
HEI.A100.0210.160-KKB	HSK 100	10	35	131	160
HEI.A100.0210.200-KKB	HSK 100	10	35	171	200
HEI.A100.0212.80-KKB	HSK 100	12	42	51	80
HEI.A100.0212.100-KKB	HSK 100	12	42	71	100
HEI.A100.0212.130-KKB	HSK 100	12	42	101	130
HEI.A100.0212.160-KKB	HSK 100	12	42	131	160
HEI.A100.0212.200-KKB	HSK 100	12	42	171	200
HEI.A100.0214.80-KKB	HSK 100	14	45	51	80
HEI.A100.0214.100-KKB	HSK 100	14	45	71	100
HEI.A100.0214.130-KKB	HSK 100	14	45	101	130
HEI.A100.0214.160-KKB	HSK 100	14	45	131	160
HEI.A100.0214.200-KKB	HSK 100	14	45	171	200

HSK-A END MILL HOLDER DIN 6359 FOR WELDON DIN 1835-B WITH COOLANT



ISO 12164-1 (DIN 69893-1) HSK FORM A

FRÄSERAUFNAHME DIN 6359 ZYLINDERSCHÄFTE DIN 1835-B MIT KÜHLMITTEL BOHRUNG

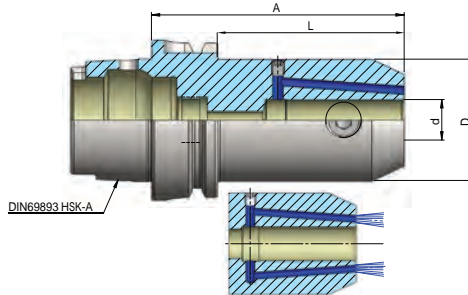
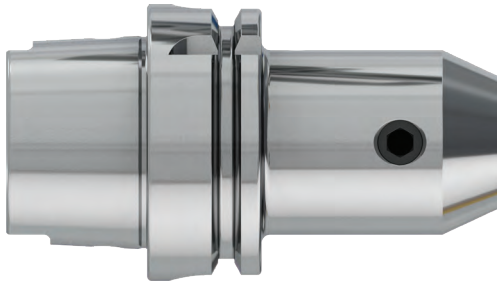

DIN
69893-1

G 2.5
25.000
MIN

COOLANT

FORM
AD

ISO
12164-1



Artikelbezeichnung Item Code	Kegel Cone	d	D	L	A
HEI.A100.0216.100-KKB	HSK 100	16	48	71	100
HEI.A100.0216.130-KKB	HSK 100	16	48	101	130
HEI.A100.0216.160-KKB	HSK 100	16	48	131	160
HEI.A100.0216.200-KKB	HSK 100	16	48	171	200
HEI.A100.0218.100-KKB	HSK 100	18	50	71	100
HEI.A100.0218.130-KKB	HSK 100	18	50	101	130
HEI.A100.0218.160-KKB	HSK 100	18	50	131	160
HEI.A100.0218.200-KKB	HSK 100	18	50	171	200
HEI.A100.0220.100-KKB	HSK 100	20	52	71	100
HEI.A100.0220.130-KKB	HSK 100	20	52	101	130
HEI.A100.0220.160-KKB	HSK 100	20	52	131	160
HEI.A100.0220.200-KKB	HSK 100	20	52	171	200
HEI.A100.0225.100-KKB	HSK 100	25	65	71	100
HEI.A100.0225.130-KKB	HSK 100	25	65	101	130
HEI.A100.0225.160-KKB	HSK 100	25	65	131	160
HEI.A100.0225.200-KKB	HSK 100	25	65	171	200
HEI.A100.0232.100-KKB	HSK 100	32	72	71	100
HEI.A100.0232.130-KKB	HSK 100	32	72	101	130
HEI.A100.0232.160-KKB	HSK 100	32	72	131	160
HEI.A100.0232.200-KKB	HSK 100	32	72	171	200
HEI.A100.0240.105-KKB	HSK 100	40	80	76	105
HEI.A100.0240.160-KKB	HSK 100	40	80	131	160
HEI.A100.0240.200-KKB	HSK 100	40	80	171	200

HSK-A SHELL MILL HOLDER DIN 6357 FOR MILLING WITH DRIVING SLOT & COOLANT

heikenei.com

ISO 12164-1 (DIN 69893-1) HSK FORM A

QUERNUT-AUFSTECKFRÄSDORN DIN 6357 MIT VERGRÖSSERTEM BUNDDURCHMESSER MIT KÜHLMITTEL

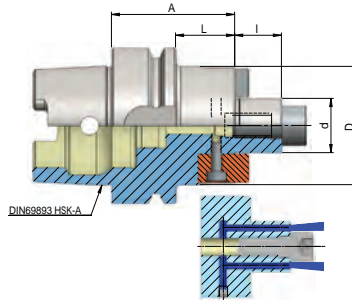

DIN
69893-1

G 2.5
25.000
MIN

COOLANT

FORM
AD

ISO
12164-1



Artikelbezeichnung Item Code	Produktname Product name	Spannbereich Capacity	D	I	L	A
HEI.A50.0316.50	HSK 50 16 - 50	16	38	17	24	50
HEI.A50.0322.60	HSK 50 22 - 60	22	48	19	34	60
HEI.A50.0327.60	HSK 50 27 - 60	27	58	21	34	60
HEI.A50.0332.60	HSK 50 32 - 60	32	78	24	34	60
HEI.A63.0316.50	HSK 63 16 - 50	16	38	17	24	50
HEI.A63.0316.100	HSK 63 16 - 100	16	38	17	74	100
HEI.A63.0316.130	HSK 63 16 - 130	16	38	17	104	130
HEI.A63.0316.160	HSK 63 16 - 160	16	38	17	134	160
HEI.A63.0322.50	HSK 63 22 - 50	22	48	19	24	50
HEI.A63.0322.100	HSK 63 22 - 100	22	48	19	74	100
HEI.A63.0322.130	HSK 63 22 - 130	22	48	19	104	130
HEI.A63.0322.160	HSK 63 22 - 160	22	48	19	134	160
HEI.A63.0327.60	HSK 63 27 - 60	27	58	21	34	60
HEI.A63.0327.100	HSK 63 27 - 100	27	58	21	74	100
HEI.A63.0327.130	HSK 63 27 - 130	27	58	21	104	130
HEI.A63.0327.160	HSK 63 27 - 160	27	58	21	134	160
HEI.A63.0332.60	HSK 63 32 - 60	32	78	24	34	60
HEI.A63.0332.100	HSK 63 32 - 100	32	78	24	74	100
HEI.A63.0332.130	HSK 63 32 - 130	32	78	24	104	130
HEI.A63.0332.160	HSK 63 32 - 160	32	78	24	134	160
HEI.A63.0340.60	HSK 63 40 - 60	40	88	27	34	60
HEI.A63.0340.100	HSK 63 40 - 100	40	88	27	74	100
HEI.A63.0340.160	HSK 63 40 - 160	40	88	27	134	160

HSK-A SHELL MILL HOLDER DIN 6357 FOR MILLING WITH DRIVING SLOT & COOLANT

ISO 12164-1 (DIN 69893-1) HSK FORM A

QUERNUT-AUFSTECKFRÄSDORN DIN 6357 MIT VERGRÖSSERTEM BUNDDURCHMESSER MIT KÜHLMITTEL

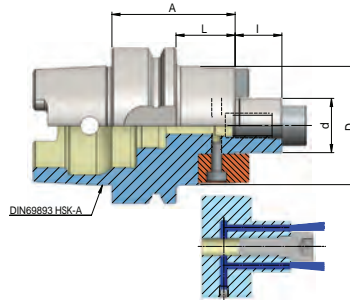
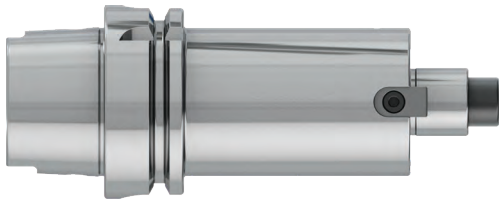

Artikelbezeichnung Item Code	Produktname Product name	Spannbereich Capacity	D	I	L	A
HEI.A100.0316.50	HSK 100 16 - 50	16	38	17	21	50
HEI.A100.0316.100	HSK 100 16 - 100	16	38	17	71	100
HEI.A100.0316.130	HSK 100 16 - 130	16	38	17	101	130
HEI.A100.0316.160	HSK 100 16 - 160	16	38	17	131	160
HEI.A100.0316.200	HSK 100 16 - 200	16	38	17	171	200
HEI.A100.0322.50	HSK 100 22 - 50	22	48	19	21	50
HEI.A100.0322.100	HSK 100 22 - 100	22	48	19	71	100
HEI.A100.0322.130	HSK 100 22 - 130	22	48	19	101	130
HEI.A100.0322.160	HSK 100 22 - 160	22	48	19	131	160
HEI.A100.0322.200	HSK 100 22 - 200	22	48	19	171	200
HEI.A100.0327.50	HSK 100 27 - 50	27	58	21	21	50
HEI.A100.0327.100	HSK 100 27 - 100	27	58	21	71	100
HEI.A100.0327.130	HSK 100 27 - 130	27	58	21	101	130
HEI.A100.0327.160	HSK 100 27 - 160	27	58	21	131	160
HEI.A100.0327.200	HSK 100 27 - 160	27	58	21	171	200
HEI.A100.0332.50	HSK 100 32 - 50	32	78	24	21	50
HEI.A100.0332.100	HSK 100 32 - 100	32	78	24	71	100
HEI.A100.0332.130	HSK 100 32 - 130	32	78	24	101	130
HEI.A100.0332.160	HSK 100 32 - 160	32	78	24	131	160
HEI.A100.0332.200	HSK 100 32 - 160	32	78	24	171	200
HEI.A100.0340.60	HSK 100 40 - 60	40	88	27	31	60
HEI.A100.0340.100	HSK 100 40 - 100	40	88	27	71	100
HEI.A100.0340.130	HSK 100 40 - 130	40	88	27	101	130
HEI.A100.0340.160	HSK 100 40 - 160	40	88	27	131	160
HEI.A100.0350.70	HSK 100 50 - 70	50	128	40	41	70
HEI.A100.0350.100	HSK 100 50 - 100	50	128	40	71	100
HEI.A100.0360.70	HSK 100 60 - 70	60	128	40	41	70

HSK-A COMBI SHELL MILL HOLDER

DIN 6358 WITH COOLANT

heikenei.com

ISO 12164-1 (DIN 69893-1) HSK FORM A

KOMBI-AUFSTECKFRÄSDORN DIN 6358 KÜHLMITTEL

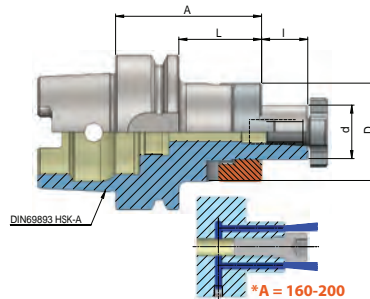

Artikelbezeichnung Item Code	Produktname Product name	Spannbereich Capacity	D	I	L	A
HEI.A50.0416.50	HSK 50 16 - 50	16	32	17	24	50
HEI.A50.0422.50	HSK 50 22 - 50	22	40	19	24	50
HEI.A50.0427.65	HSK 50 27 - 65	27	48	21	39	65
HEI.A50.0432.65	HSK 50 32 - 65	32	58	24	39	65
HEI.A63.0416.60	HSK 63 16 - 60	16	32	17	34	60
HEI.A63.0416.100	HSK 63 16 - 100	16	32	17	74	100
HEI.A63.0416.130	HSK 63 16 - 130	16	32	17	104	130
HEI.A63.0416.160	HSK 63 16 - 160	16	32	17	134	160
HEI.A63.0422.60	HSK 63 22 - 60	22	40	19	34	60
HEI.A63.0422.100	HSK 63 22 - 100	22	40	19	74	100
HEI.A63.0422.130	HSK 63 22 - 130	22	40	19	104	130
HEI.A63.0422.160	HSK 63 22 - 160	22	40	19	134	160
HEI.A63.0427.60	HSK 63 27 - 60	27	48	21	34	60
HEI.A63.0427.100	HSK 63 27 - 100	27	48	21	74	100
HEI.A63.0427.130	HSK 63 27 - 130	27	48	21	104	130
HEI.A63.0427.160	HSK 63 27 - 160	27	48	21	134	160
HEI.A63.0432.60	HSK 63 32 - 60	32	58	24	34	60
HEI.A63.0432.100	HSK 63 32 - 100	32	58	24	74	100
HEI.A63.0432.130	HSK 63 32 - 130	32	58	24	104	130
HEI.A63.0432.160	HSK 63 32 - 160	32	58	24	134	160
HEI.A63.0440.70	HSK 63 40 - 70	40	70	27	44	70
HEI.A63.0440.100	HSK 63 40 - 100	40	70	27	74	100

HSK-A COMBI SHELL MILL HOLDER DIN 6358 WITH COOLANT

ISO 12164-1 (DIN 69893-1) HSK FORM A
KOMBI-AUFSTECKFRÄSDORN DIN 6358 KÜHLMITTEL

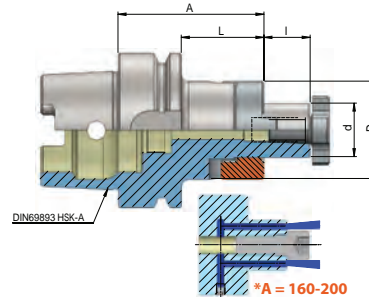

Artikelbezeichnung Item Code	Produktname Product name	d	D	l	L	A
HEI.A100.0416.60	HSK 100 16 - 60	16	32	17	31	60
HEI.A100.0416.100	HSK 100 16 - 100	16	32	17	71	100
HEI.A100.0416.130	HSK 100 16 - 130	16	32	17	101	130
HEI.A100.0416.160	HSK 100 16 - 160	16	32	17	131	160
HEI.A100.0416.200	HSK 100 16 - 200	16	32	17	171	200
HEI.A100.0422.60	HSK 100 22 - 60	22	40	19	31	60
HEI.A100.0422.100	HSK 100 22 - 100	22	40	19	71	100
HEI.A100.0422.130	HSK 100 22 - 130	22	40	19	101	130
HEI.A100.0422.160	HSK 100 22 - 160	22	40	19	131	160
HEI.A100.0422.200	HSK 100 22 - 200	22	40	19	171	200
HEI.A100.0427.60	HSK 100 27 - 60	27	48	21	31	60
HEI.A100.0427.100	HSK 100 27 - 100	27	48	21	71	100
HEI.A100.0427.130	HSK 100 27 - 130	27	48	21	101	130
HEI.A100.0427.160	HSK 100 27 - 160	27	48	21	131	160
HEI.A100.0427.200	HSK 100 27 - 200	27	48	21	171	200
HEI.A100.0432.60	HSK 100 32 - 60	32	58	24	31	60
HEI.A100.0432.100	HSK 100 32 - 100	32	58	24	71	100
HEI.A100.0432.130	HSK 100 32 - 130	32	58	24	101	130
HEI.A100.0432.160	HSK 100 32 - 160	32	58	24	131	160
HEI.A100.0432.200	HSK 100 32 - 200	32	58	24	171	200
HEI.A100.0440.70	HSK 100 40 - 70	40	70	27	41	70
HEI.A100.0440.100	HSK 100 40 - 100	40	70	27	71	100
HEI.A100.0440.130	HSK 100 40 - 130	40	70	27	101	130
HEI.A100.0440.160	HSK 100 40 - 160	40	70	27	131	160

HSK-A MORSE TAPER ADAPTOR DIN 5383

heikenei.com

ISO 12164-1 (DIN 69893-1) HSK FORM A

ZWISCHENHÜLSE FÜR MK MIT AUSTREIBBLAPPEN DIN 6383

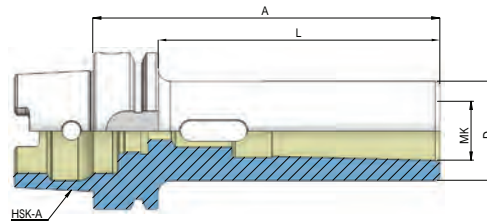
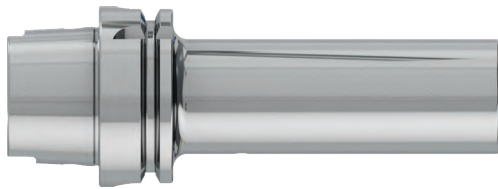

DIN
69893-1

G 2.5
25.000
MIN

FORM
AD

ISO
12164-1

Artikelbezeichnung Item Code	Produktname Product name	MK	D	L	A
HEI.A50.0501.100	HSK 50 1 - 100	1	25	74	100
HEI.A50.0502.120	HSK 50 2 - 120	2	32	94	120
HEI.A50.0503.140	HSK 50 3 - 140	3	40	114	140
HEI.A63.0501.100	HSK 63 1 - 100	1	25	74	100
HEI.A63.0502.120	HSK 63 2 - 120	2	32	94	120
HEI.A63.0503.140	HSK 63 3 - 140	3	40	114	140
HEI.A63.0504.160	HSK 63 4 - 160	4	48	134	160
HEI.A100.0501.110	HSK 100 1 - 110	1	25	81	110
HEI.A100.0502.120	HSK 100 2 - 120	2	32	91	120
HEI.A100.0503.150	HSK 100 3 - 150	3	40	121	150
HEI.A100.0504.170	HSK 100 4 - 170	4	48	141	170
HEI.A100.0505.200	HSK 100 5 - 200	5	63	171	200

HSK-A MORSE TAPER ADAPTOR WITH THREAD DIN 6364

ISO 12164-1 (DIN 69893-1) HSK FORM A
ZWISCHENHÜLSE FÜR MK MIT AUSTREIBBLAPPEN DIN 6383

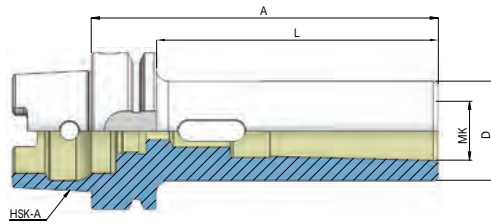
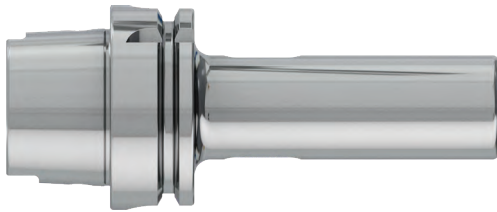

DIN
69893-1

G 2.5
25.000
MIN

ISO
12164-1

Artikelbezeichnung Item Code	Produktname Product name	MK	D	L	A
HEI.A63.0601.100	HSK 63 1 - 100	1	25	74	100
HEI.A63.0602.120	HSK 63 2 - 120	2	32	94	120
HEI.A63.0603.140	HSK 63 3 - 140	3	40	114	140
HEI.A63.0604.160	HSK 63 4 - 160	4	48	134	160
HEI.A100.0601.110	HSK 100 1 - 110	1	25	81	110
HEI.A100.0602.120	HSK 100 2 - 120	2	32	91	120
HEI.A100.0603.150	HSK 100 3 - 150	3	40	121	150
HEI.A100.0604.170	HSK 100 4 - 170	4	48	141	170
HEI.A100.0605.200	HSK 100 5 - 200	5	63	171	200

HSK-A FOR MODULAR (SCREW TYPE) INDEXABLE END MILLS

heikenei.com

ISO 12164-1 (DIN 69893-1) HSK FORM A
FRÄSAUFNAHME FÜR EINSCHRAUBFRÄSER

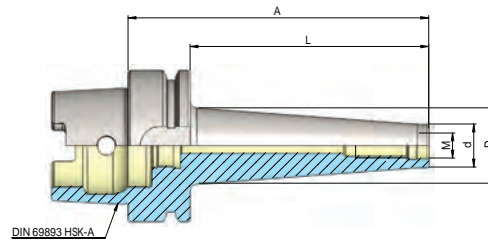

Artikelbezeichnung Item Code	Produktname Product name	Spannbereich Capacity	d	D	L	A
HEI.A63.0806.51	HSK63M6- 51	M6	10	13	25	51
HEI.A63.0808.51	HSK 63 M8 - 51	M8	13	15	25	51
HEI.A63.0808.76	HSK 63 M8 - 76	M8	13	23	50	76
HEI.A63.0808.101	HSK 63 M8 - 101	M8	13	23	75	101
HEI.A63.0810.51	HSK 63 M10 - 51	M10	18	20	25	51
HEI.A63.0810.76	HSK 63 M10 - 76	M10	18	23	50	76
HEI.A63.0810.126	HSK 63 M10 - 126	M10	18	32	100	126
HEI.A63.0810.176	HSK 63 M10 - 176	M10	18	36	150	176
HEI.A63.0812.51	HSK 63 M12 - 51	M12	21	24	25	51
HEI.A63.0812.76	HSK 63 M12 - 76	M12	21	27	50	76
HEI.A63.0812.101	HSK 63 M12 - 101	M12	21	30	75	101
HEI.A63.0812.126	HSK 63 M12 - 126	M12	21	33	100	126
HEI.A63.0812.176	HSK 63 M12 - 176	M12	21	40	150	176
HEI.A63.0816.51	HSK 63 M16 - 51	M16	29	29	25	51
HEI.A63.0816.76	HSK 63 M16 - 76	M16	29	32	50	76
HEI.A63.0816.101	HSK 63 M16 - 101	M16	29	34	75	101
HEI.A63.0816.126	HSK 63 M16 - 126	M16	29	36	100	126
HEI.A63.0816.176	HSK 63 M16 - 176	M16	29	42	150	176
HEI.A100.0808.79	HSK 100 M8 - 79	M8	13	23	50	79
HEI.A100.0810.79	HSK 100 M10 - 79	M10	18	23	50	79
HEI.A100.0810.129	HSK 100 M10 - 129	M10	18	32	100	129
HEI.A100.0810.179	HSK 100 M10 - 179	M10	18	36	150	179
HEI.A100.0812.79	HSK 100 M12 - 79	M12	21	24	50	79
HEI.A100.0812.129	HSK 100 M12 - 129	M12	21	33	100	129
HEI.A100.0812.179	HSK 100 M12 - 179	M12	21	40	150	179
HEI.A100.0816.79	HSK 100 M16 - 79	M16	29	34	50	79
HEI.A100.0816.129	HSK 100 M16 - 129	M16	29	36	100	129
HEI.A100.0816.179	HSK 100 M16 - 179	M16	29	42	150	179

HSK-A HOLDER FOR INDEXABLE DRILLS E1

ISO 12164-1 (DIN 69893-1) HSK FORM A

BOHRERHALTER FÜR WENDEPLATTENBOHRER E1

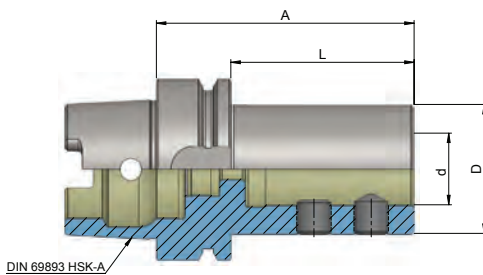

Artikelbezeichnung Item Code	Produktname Product name	Spannbereich Capacity	D	L	A
HEI.A63.1420.80	HSK 63 20 - 80 - E1	20	40	54	80
HEI.A63.1425.90	HSK 63 25 - 90 - E1	25	45	64	90
HEI.A63.1432.90	HSK 63 32 - 90 - E1	32	52	64	90
HEI.A100.1420.90	HSK 100 20 - 90 - E1	20	40	61	90
HEI.A100.1425.95	HSK 100 25 - 95 - E1	25	45	66	95
HEI.A100.1432.100	HSK 100 32 - 100 - E1	32	52	71	100
HEI.A100.1440.110	HSK 100 40 - 110 - E1	40	60	81	110

HSK-A BLANK BAR

heikenei.com

ISO 12164-1 (DIN 69893-1) HSK FORM A

BOHRSTANGENROHLING ZUR ANFERTIGUNG VON SONDERWERKZEUGEN

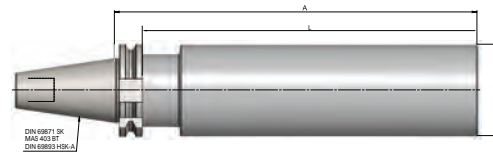

Artikelbezeichnung Item Code	Produktname Product name	D	L	A
HEI.A50.1050.150	HSK 50 50 - 150	50	124	150
HEI.A63.1063.160	HSK 63 63 - 160	63	134	160
HEI.A100.1097.250	HSK 100 97 - 250	97	221	250

DIN 2080 SK (ISO)

heikenei.com





PG. 82 - 92

DIN 2080 SK (ISO) DIMENSION

heikenei.com

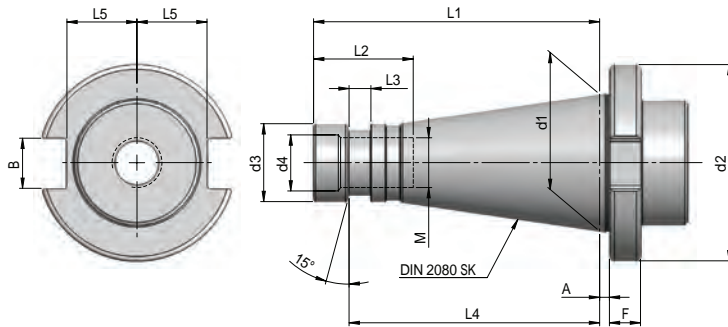

Dimensions	Ø d1	Ø d2	Ø d3	Ø d4	M	A	F	L1	L2	L3	L4	L5	B
SK40	44,45	63	25	17	M16	1,6	10	93,4	32	7	82	22,5	16,1
SK50	69,85	97,5	39	25	M24	3,2	12	126,8	47	*	*	35,3	25,7

COLLET CHUCKS FOR COLLETS DIN 6499 ER

DIN 2080 SK (ISO)

SPANNZANGENFUTTER DIN 6499 ER

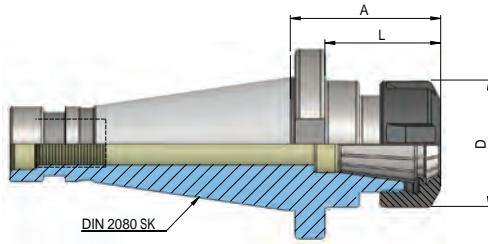

Artikelbezeichnung Item Code	Kegel Cone	Spannbereich Capacity	D	L	A
HEI.D40.0116.50	SK 40	1 - 10	28	38	50
HEI.D40.0125.50	SK 40	2 - 16	42	38	50
HEI.D40.0132.50	SK 40	2 - 20	50	38	50
HEI.D40.0140.80	SK 40	3 - 26	63	68	80
HEI.D50.0132.63	SK 50	2 - 20	50	48	63
HEI.D50.0140.63	SK 50	3 - 26	63	48	63

COLLET CHUCKS DIN 6391 FOR COLLETS DIN 6388-OZ

heikenei.com

DIN 2080 SK (ISO)

SPANNFUTTER DIN 6391 FÜR SPANNZANGEN DIN 6388-OZ

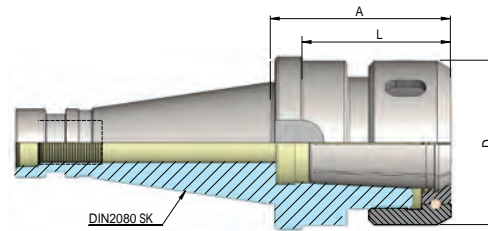

Artikelbezeichnung Item Code	Kegel Cone	Spannbereich Capacity	D	L	A
HEI.D40.0116.55.OZ	SK 40	2 - 16	43	43	55
HEI.D40.0125.66.OZ	SK 40	2 - 25	60	54	66
HEI.D40.0125.95.OZ	SK 40	3 - 32	72	83	95
HEI.D50.0125.71.OZ	SK 50	2 - 25	60	59	71
HEI.D50.0132.73.OZ	SK 50	3 - 32	72	58	73

END MILL HOLDER DIN 6359 FOR WELDON DIN 1835-B

DIN 2080 SK (ISO)

FRÄSERAUFNAHME DIN 6359 ZYLINDERSCHÄFTE DIN 1835-B

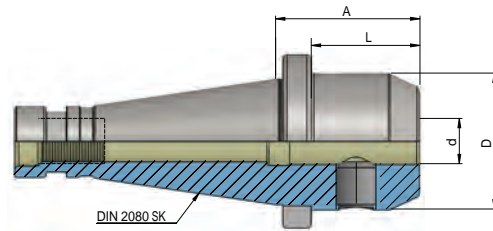

Artikelbezeichnung Item Code	Kegel Cone	d	D	L	A
HEI.D40.0206.50	SK40	6	25	38	50
HEI.D40.0208.50	SK40	8	28	38	50
HEI.D40.0210.50	SK40	10	35	38	50
HEI.D40.0212.50	SK40	12	42	38	50
HEI.D40.0214.50	SK40	14	45	38	50
HEI.D40.0216.63	SK40	16	48	51	63
HEI.D40.0218.63	SK40	18	50	51	63
HEI.D40.0220.63	SK40	20	52	51	63
HEI.D40.0225.80	SK40	25	63	68	80
HEI.D40.0232.80	SK40	32	72	68	80
HEI.D40.0240.90	SK40	40	80	78	90
HEI.D50.0206.63	SK50	6	25	48	63
HEI.D50.0208.63	SK50	8	28	48	63
HEI.D50.0210.63	SK50	10	35	48	63
HEI.D50.0212.63	SK50	12	42	48	63
HEI.D50.0214.63	SK50	14	45	48	63
HEI.D50.0216.63	SK50	16	48	48	63
HEI.D50.0218.63	SK50	18	50	48	63
HEI.D50.0220.63	SK50	20	52	48	63
HEI.D50.0225.80	SK50	25	65	65	80
HEI.D50.0232.80	SK50	32	72	65	80
HEI.D50.0240.90	SK50	40	80	75	90

SHELL MILL HOLDER DIN 6357 FOR FACE MILLS WITH DRIVING SLOT

heikenei.com

DIN 2080 SK (ISO)

SCHAFTFRÄSERHALTER DIN 6357 MIT MITNEHMERNUT

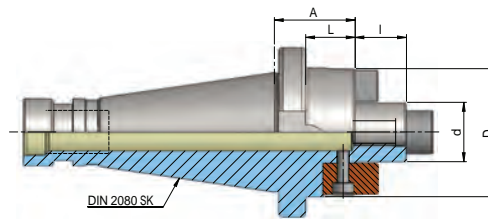
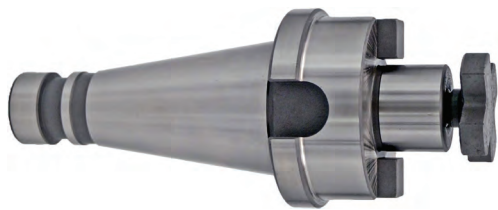

Artikelbezeichnung Item Code	Kegel Cone	d	D	l	L	A
HEI.D40.0316.30	SK40	16	48	17	18	30
HEI.D40.0322.30	SK40	22	48	19	18	30
HEI.D40.0327.30	SK40	27	58	21	18	30
HEI.D40.0332.30	SK40	32	78	24	18	30
HEI.D40.0340.30	SK40	40	88	27	18	30
HEI.D50.0322.35	SK50	22	48	19	20	35
HEI.D50.0327.35	SK50	27	58	21	20	35
HEI.D50.0332.40	SK50	32	78	24	25	40
HEI.D50.0340.33	SK50	40	88	27	18	33
HEI.D50.0360.55	SK50	60	128	40	40	55

COMBI SHELL MILL HOLDER DIN 6358 FOR FACE MILLS

DIN 2080 SK (ISO)

KOMBI-AUFSTECKFRÄSDORN DIN 6358

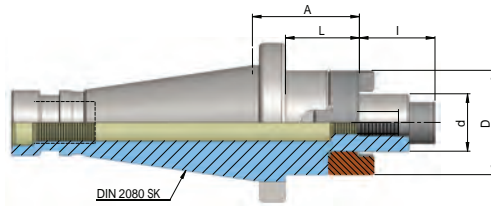

Artikelbezeichnung Item Code	Kegel Cone	d	D	I	L	A
HEI.D40.0416.52	SK40	16	32	17	40	52
HEI.D40.0422.52	SK40	22	40	19	40	52
HEI.D40.0427.52	SK40	27	48	21	40	52
HEI.D40.0432.52	SK40	32	58	24	40	52
HEI.D40.0440.52	SK40	40	70	27	40	52
HEI.D50.0416.55	SK50	16	32	17	40	55
HEI.D50.0422.55	SK50	22	40	19	40	55
HEI.D50.0427.55	SK50	27	48	21	40	55
HEI.D50.0432.55	SK50	32	58	24	40	55
HEI.D50.0440.55	SK50	40	70	27	40	55

MORSE TAPER ADAPTOR DIN 6383

heikenei.com

DIN 2080 SK (ISO)

ZWISCHENHÜLSE FÜR MK MIT AUSTREIBLAPPEN DIN 6383

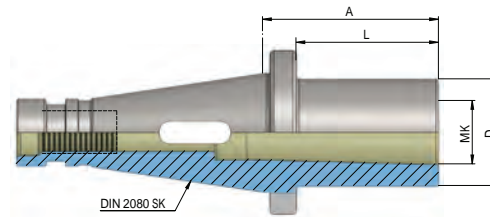

Artikelbezeichnung Item Code	Kegel Cone	MK	D	L	A
HEI.D40.0601.50	SK40	1	25	38	50
HEI.D40.0602.50	SK40	2	32	38	50
HEI.D40.0603.65	SK40	3	40	53	65
HEI.D40.0604.95	SK40	4	48	83	95
HEI.D50.0601.60	SK50	1	25	45	60
HEI.D50.0602.60	SK50	2	32	45	60
HEI.D50.0603.65	SK50	3	40	50	65
HEI.D50.0604.65	SK50	4	48	50	65
HEI.D50.0605.120	SK50	5	63	105	120

MORSE TAPER ADAPTOR WITH THREAD DIN 6364

DIN 2080 SK (ISO)

ZWISCHENHÜLSE FÜR MK MIT ANZUGSGEWINDE DIN 6364

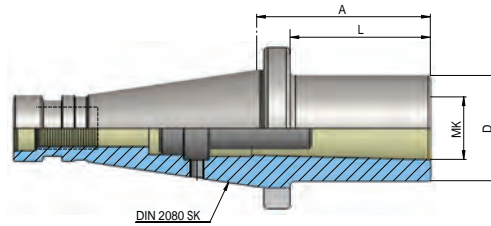
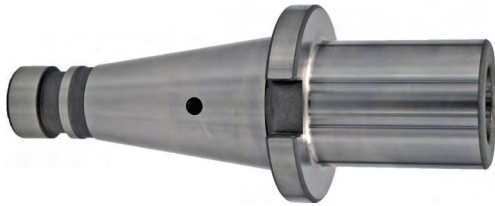

Artikelbezeichnung Item Code	Kegel Cone	MK	D	L	A
HEI.D40.0501.50	SK40	1	25	38	50
HEI.D40.0502.50	SK40	2	32	38	50
HEI.D40.0503.65	SK40	3	40	53	65
HEI.D40.0504.95	SK40	4	48	83	95
HEI.D50.0501.45	SK50	1	25	30	45
HEI.D50.0502.60	SK50	2	32	45	60
HEI.D50.0503.65	SK50	3	40	50	65
HEI.D50.0504.70	SK50	4	48	55	70
HEI.D50.0505.105	SK50	5	63	90	105

REDUCING ADAPTER

DIN 2080 SK (ISO)

ZWISCHENHÜLSE/REDUZIERHÜLSE

heikenei.com

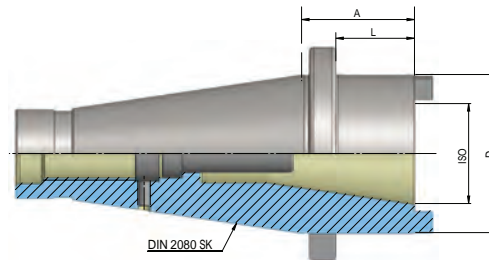

Artikelbezeichnung Item Code	Kegel Cone	ISO	D	L	A
HEI.D40.0730.50	SK40	SK30 - BT30	50	38	50
HEI.D40.0740.100	SK40	SK40 - BT40	63	88	100
HEI.D50.0740.50	SK50	SK40 - BT40	70	35	50
HEI.D50.0750.125	SK50	SK50 - BT50	97	110	125

DRILL CHUCK ADAPTOR DIN 238

DIN 2080 SK (ISO)

BOHRFUTTERAUFNAHME DIN 238

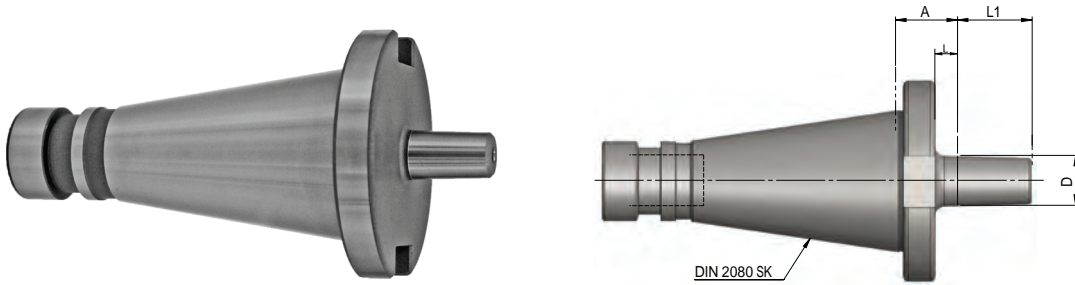

Artikelbezeichnung Item Code	Kegel Cone	D	L	L1	A
HEI.D40.0912.15	SK 40	B12	3	18	15
HEI.D40.0916.17	SK 40	B16	5	24	17
HEI.D40.0918.17	SK 40	B18	5	32	17
HEI.D50.0916.20	SK 50	B16	5	24	20
HEI.D50.0918.20	SK 50	B18	5	32	20

BLANK BAR

DIN 2080 SK (ISO)

BOHRSTANGENROHLING ZUR ANFERTIGUNG VON SONDERWERKZEUGEN

heikenei.com

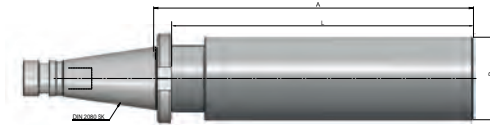

Artikelbezeichnung Item Code	Kegel Cone	D	L	A
HEI.D40.1063.250	SK 40	63	238	250
HEI.D50.1097.315	SK50	97	300	315

ZUBEHÖR / ACCESSORIES

DRIVING BLOCKS

MITNEHMERSTEINE MIT SCHRAUBE

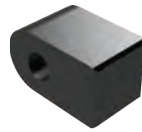
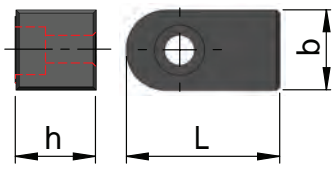

FIG1

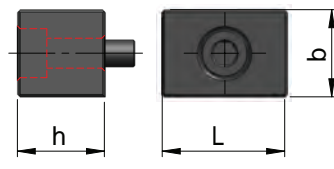
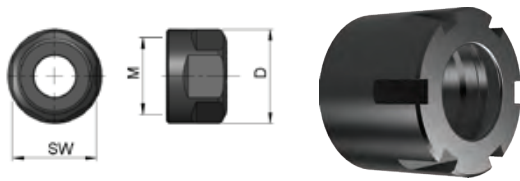

FIG2

Artikelbezeichnung Item Code	Produktname Product Name	b	h	L	FIG
HEI.Z.MS.Q316.17	Q 16 QUERNUT	8	9	17	FIG1
HEI.Z.MS.Q322.17	Q 22 QUERNUT	10	10	17	FIG1
HEI.Z.MS.Q327.23	Q 27 QUERNUT	12	12	23	FIG1
HEI.Z.MS.Q332.27	Q 32 QUERNUT	14	15	27	FIG1
HEI.Z.MS.Q340.28	Q 40 QUERNUT	16	16	28	FIG1
HEI.Z.MS.Q327.14	Q 27 QUERNUT	12	12	14	FIG2
HEI.Z.MS.Q332.22	Q 32 QUERNUT	14	14	22	FIG2
HEI.Z.MS.Q340.23	Q 40 QUERNUT	16	16	23	FIG2

MINI ER COLLET



Artikelbezeichnung Item Code	Produktname Product Name	M	D
HEI.Z.SM16.ER16.6KT	ER 16 SW 25	M22 x 1,5	28
HEI.Z.SM20.ER20	ER 20	M25 x 1,5	35
HEI.Z.SM25.ER25	ER 25	M32 x 1,5	42
HEI.Z.SM32.ER32	ER 32	M40 x 1,5	50
HEI.Z.SM40.ER40	ER 40	M50 x 1,5	63
HEI.Z.SM11.ER11.M	ER 11 MINI	M13 x 0,75	16
HEI.Z.SM16.ER16.M	ER 16 MINI	M19 x 1,0	22
HEI.Z.SM20.ER20.M	ER 20 MINI	M24 x 1,0	28
HEI.Z.SM25.ER25.M	ER 25 MINI	M30 x 1,0	35
HEI.Z.SM16.E410.OZ	OZ 410 E	M33 x 1,5	43
HEI.Z.SM25.E444.OZ	OZ 444 E	M48 x 2,0	60
HEI.Z.SM32.E450.OZ	OZ 450 E	M60 x 2,5	72

ER COLLET

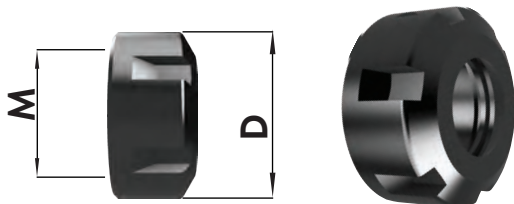

OZ COLLET

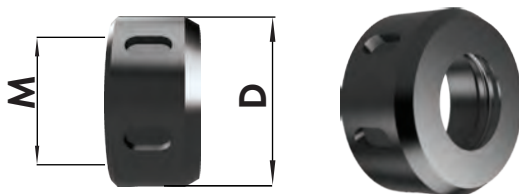

Spannmutter ER DIN 6499/ DIN 6388 (OZ) Standardausführung mit Exzenterring - gewuchtet
Clamping nuts ER DIN 6499 / DIN 6388 - balanced

ZUBEHÖR / ACCESSORIES

heikenei.com

MITNEHMERRINGE DIN 6366

CLUTCH DRIVE RINGS TO DIN 6366

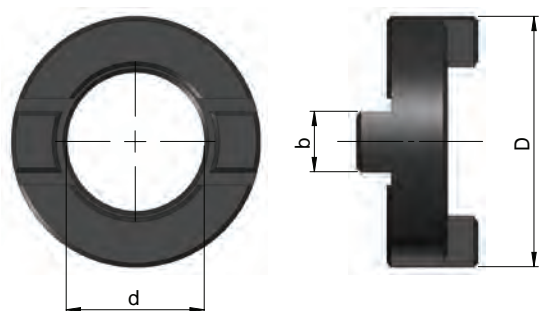

Artikelbezeichnung Item Code	Produktname Product Name	d	D	b
HEI.Z.MR.K416.16	Q 16 KOMBI	16	32	8
HEI.Z.MR.K422.22	Q 22 KOMBI	22	40	10
HEI.Z.MR.K427.27	Q 27 KOMBI	27	48	12
HEI.Z.MR.K432.32	Q 32 KOMBI	32	58	14
HEI.Z.MR.K440.40	Q 40 KOMBI	40	70	16

FRÄSERANZUGSCHRAUBEN DIN 6367

DRAWN IN BOLT DIN 6367

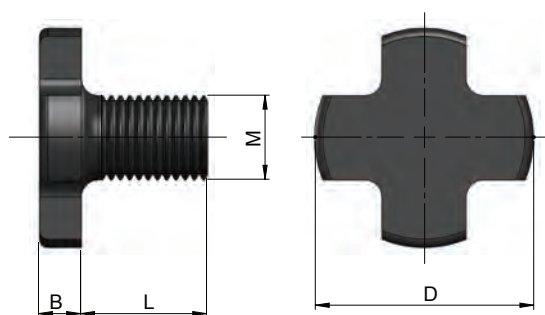

Artikelbezeichnung Item Code	Produktname Product Name	M	D	L	B
HEI.Z.FAS.K16.M8	M8 Q16 KOMBI	M8	20	16	6
HEI.Z.FAS.K22.M10	M10 Q 22 KOMBI	M10	28	18	7
HEI.Z.FAS.K27.M12	M12 Q 27 KOMBI	M12	35	22	8
HEI.Z.FAS.K32.M16	M16 Q 32 KOMBI	M16	42	26	9
HEI.Z.FAS.K40.M20	M20 Q 40 KOMBI	M20	52	30	10
HEI.Z.FAS.K50.M24	M24 Q 40 KOMBI	M24	63	36	12

DRIVE KEY

MITNEHMERSTEINE MIT SCHRAUBE

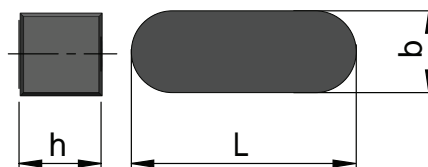

Artikelbezeichnung Item Code	Produktname Product Name	b	h	L
HEI.Z.PF.K416.20	Drive Key K 16 Kombi	4	4	20
HEI.Z.PF.K422.20	Drive Key K 22 Kombi	6	6	20
HEI.Z.PF.K427.25	Drive Key K 27 Kombi	7	7	25
HEI.Z.PF.K432.28	Drive Key K 32 Kombi	7	8	28
HEI.Z.PF.K440.32	Drive Key K 40 Kombi	8	10	32

ZUBEHÖR / ACCESSORIES

CLAMPING SCREW FOR WELDON AND WHISTLE NOTCH WHISTLE NOTCH SPANNSCHRAUBE

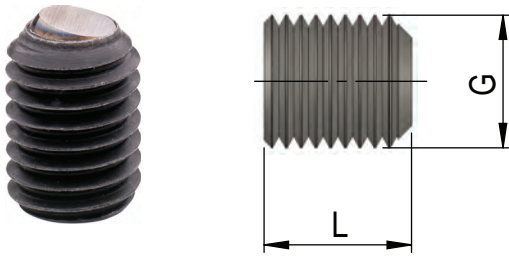

Artikelbezeichnung Item Code	Produktname Product Name	G	L
HEI.Z.SCH.M6X10WN	WELDON 6	M6	10
HEI.Z.SCH.M8X10WN	WELDON 8	M8	10
HEI.Z.SCH.M10X12WN	WELDON 10	M10	12
HEI.Z.SCH.M12X16WN	WELDON 12-14	M12	16
HEI.Z.SCH.M14X16WN	WELDON 16-18	M14	16
HEI.Z.SCH.M16X16WN	WELDON 20	M16	16
HEI.Z.SCH.M18X2X20WN	WELDON 25	M18x2	20
HEI.Z.SCH.M20X2X20WN	WELDON 32-40	M20x2	20

SCREW FOR WELDON DIN 1835 B WELDON-SPANNSCHRAUBE DIN 1835 B



Artikelbezeichnung Item Code	Produktname Product Name	G	L
HEI.Z.SCH.M6X10	WELDON 6	M6	10
HEI.Z.SCH.M8X10	WELDON 8	M8	10
HEI.Z.SCH.M10X12	WELDON 10	M10	12
HEI.Z.SCH.M12X16	WELDON 12-14	M12	16
HEI.Z.SCH.M14X16	WELDON 16-18	M14	16
HEI.Z.SCH.M16X16	WELDON 20	M16	16
HEI.Z.SCH.M18X2X20	WELDON 25	M18x2	20
HEI.Z.SCH.M20X2X20	WELDON 32-40	M20x2	20

CLAMPING SCREW DIN 913 - DIN 914 SPANNSCHRAUBEN DIN 913 - DIN 914



Artikelbezeichnung Item Code	Produktname Product Name	G	L
HEI.Z.SCH.M10X1X12	CLAMPING SCREW 20	M12x1	12
HEI.Z.SCH.M12X1X12	CLAMPING SCREW 25	M12x1	12
HEI.Z.SCH.M12X1X12	CLAMPING SCREW 32	M12x1	12
HEI.Z.SCH.M16X1X12	CLAMPING SCREW 40-50	M16x1	12
HEI.Z.SCH.M10X1X14	CLAMPING SCREW 20	M10x1	14
HEI.Z.SCH.M12X1X14	CLAMPING SCREW 25	M12x1	14
HEI.Z.SCH.M12X1X14	CLAMPING SCREW 32	M12x1	14
HEI.Z.SCH.M16X1X14	CLAMPING SCREW 40-50	M16x1	14

CLAMPING SCREW DIN 1835 B SPANNSCHRAUBEN DIN 1835 B

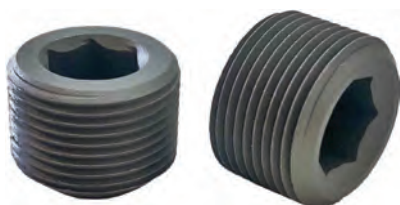

Artikelbezeichnung Item Code	Produktname Product Name	G	L
HEI.SCH.M16X14K	WELDON KURZ 20	M16	16
HEI.SCH.M16X1X8K	WELDON KURZ 25-32	M16x1	8
HEI.SCH.M16X1X10K	WELDON KURZ 25-32	M16x1	12



heikenei.com

HEIKENEI[®]

wir produzieren industrielle lösungen

Our competent employees will be happy to advise you and support you in the implementation of your projects.

CONTACT US NOW!

Unsere kompetenten Mitarbeiter beraten Sie gerne und unterstützen Sie bei der Umsetzung Ihrer Projekte.

KONTAKTIEREN SIE UNS JETZT!



heikenei.com
info@heikenei.com

